

Contents:

SECTION 2 - BASIC COMMANDS

Introduction.....	3
Labels	4
Comments	4
Constants.....	5
Symbols	5
Variables	6
backward	9
branch	10
button	11
calibfreq	13
count	14
debug	15
data	16
eeprom	16
end	17
for...next	18
forward	19
gosub	20
goto	21
halt	22
high	23
high portc.....	24
i2cslave	25
if...then	27
if...and...then	27
if...or...then	27
infrain	29
infrain2	31
infraout	32
input	37
keyin	38
keyled	40
let	41
let dirs =	43
let dirsc =	43
let pins =	44
let pinsc =	44
lookdown	45
lookup	46
low	47
low portc	48
nap	49
output	50
pause	51
peek	52
play	53
poke	54
pulsin	55
pulsout	56
pwm	57
pwmout	58

random	59
readadc	60
readadc10	62
readi2c	63
read	64
readmem	65
readtemp	66
readtemp12	67
readowclk	68
resetowclk	69
readown	70
return	72
reverse	73
serin	74
serout	76
sertxd	77
servo	78
setint	79
setfreq	82
shiftin	83
shiftout	85
sleep	86
sound	87
stop	88
switch on/off	89
symbol	90
toggle	91
tune	92
wait	99
write	100
writemem	101
writei2c	102
Additional Reserved Keywords	103
Software Version	103
Contact Address:	103
Acknowledgements:	103

BASIC COMMANDS

Introduction.

The PICAXE manual is divided into three sections:

- Section 1 - Getting Started
- Section 2 - BASIC Commands
- Section 3 - Microcontroller interfacing circuits

This second section provides the syntax (with detailed examples) for all the BASIC commands supported by the PICAXE system. It is intended as a lookup reference guide for each BASIC command supported by the PICAXE system. As some commands only apply to certain size PICAXE chips, a diagram beside each command indicates the sizes of PICAXE that the command applies to.

When using the flowchart method of programming, only a small sub-set of the available commands are supported by the on-screen simulation. These commands are indicated by the corresponding flowchart icon by the description.

For more general information about how to use the PICAXE system, please see section 1 'Getting Started'.

The software used for programming the PICAXE is called the 'Programming Editor'. This software is free to download from www.picaxe.co.uk. Please see section 1 of the manual ('Getting Started') for installation details and tutorials. This manual was prepared using Version 4.1.0 of the Programming Editor software.

The latest version of this document is available on the PICAXE website at

www.picaxe.co.uk

If you have a question about any command please post a question on the very active support forum at this website.

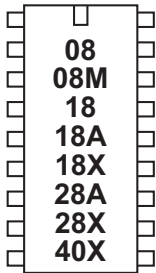

Labels

Labels are used as markers throughout the program. Labels are used to mark a position in the program to 'jump to' at a later point using a goto, gosub or other command. Labels can be any word (that is not already a reserved keyword) and may contain digits and the underscore character. Labels must start with a letter (not digit), and are defined with a colon (:) at the marker position. The colon is not required within the actual commands.

The compiler is not case sensitive (lower and/or upper case may be used at any time).

Example:

```
loop:
    high 1           \ switch on output 1
    pause 5000      \ wait 5 seconds
    low 1           \ switch off output 1
    pause 5000      \ wait 5 seconds
    goto loop       \ loop back to start
```

Whitespace

Whitespace is the term used by programmers to define the white area on a printout of the program. This involves spaces, tabs and empty lines. Any of these features can be used to space the program to make it clearer and easier to read.

It is convention to only place labels on the left hand side of the screen. All other commands should be indented by using the 'tab key'. This convention makes the program much easier to read and follow.

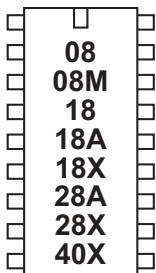

Comments

Comments are used to add information into the program for future reference. They are completely ignored by the computer during a download. Comments begin with an apostrophe (') or semi-colon (;) and continue until the end of the line. The keyword REM may also be used for a comment.

Examples:

```
high 0           \ make output 0 high
high 0           ; make output 0 high
high 0           REM make output 0 high
```

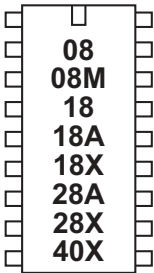

Constants

Constants are 'fixed' numbers that are used within the program. The software supports word integers (any whole number between 0 and 65535).

Constants can be declared in four ways: decimal, hex, binary, and ASCII.

Decimal	numbers are typed directly without any prefix.
Hexadecimal (hex)	numbers are preceded with a dollar-sign (\$) or (0x).
Binary	numbers are preceded by a percent-sign (%).
ASCII text strings	are enclosed in quotes (").

Examples:

```
100           \ 100 decimal
$64          \ 64 hex
%01100100   \ 01100100 binary
"A"          \ "A" ascii (65)
"Hello"      \ "Hello" - equivalent to "H","e","l","l","o"
B1 = B0 ^ $AA \ xor variable B0 with AA hex
```

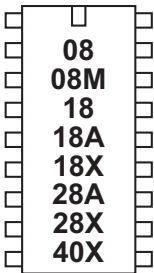

Symbols

Symbols can be assigned to constant values, and can also be used as alias names for variables (see Variables overleaf for more details). Constant values and variable names are assigned by following the symbol name with an equal-sign (=), followed by the variable or constant.

Symbols can use any word that is not a reserved keyword (e.g. switch, step, output, input, etc.)

Symbols can contain numeric characters and underscores (flash1, flash_2 etc.) but the first character cannot be a numeric (e.g. 1flash)

Use of symbol does not increase program length. See the symbol command entry later in this manual for more information.

Example:

```
symbol RED_LED = 7   \ define a constant symbol
symbol COUNTER = b0 \ define a variable symbol
let COUNTER = 200   \ preload variable with value 200
loop:                \ define a program address
                    \ address symbol end with colons
high RED_LED        \ switch on output 7
pause COUNTER       \ wait 0.2 seconds
low RED_LED         \ switch off output 7
pause COUNTER       \ wait 0.2 seconds
goto loop           \ loop back to start
```

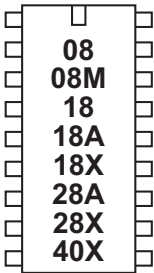

Variables

The RAM memory is used to store temporary data in variables as the program runs. It loses all data when the power is removed or reset. There are three types of variable - general purpose, storage, and special function.

See the 'let' command for details about variable mathematics.

General Purpose Variables.

There are 14 general purpose byte variables. These byte variables are labelled b0 to b13. Byte variables can store integer numbers between 0 and 255. Byte variables cannot use negative numbers or fractions, and will 'overflow' without warning if you exceed the 0 or 255 boundary values (e.g. $254 + 3 = 1$) ($2 - 3 = 255$).

However for larger numbers two byte variables can be combined to create a word variable, which is capable of storing integer numbers between 0 and 65535. These word variables are labelled w0 to w6, and are constructed as follows:

w0 = b1 : b0
 w1 = b3 : b2
 w2 = b5 : b4
 w3 = b7 : b6

w4 = b9 : b8
 w5 = b11 : b10
 w6 = b13 : b12

Therefore the most significant byte of w0 is b1, and the least significant byte of w0 is b0.

In addition bytes b0 and b1 (w0) are broken down into individual bit variables. These bit variables can be used where you just require a single bit (0 or 1) storage capability.

b0 = bit7: bit6: bit5: bit4: bit3: bit2: bit1: bit0
 b1 = bit15: bit14: bit13: bit12: bit11: bit10: bit9: bit8

You can use any word, byte or bit variable within any mathematical assignment or command that supports variables. However take care that you do not accidentally repeatedly use the same 'byte' or 'bit' variable that is being used as part of a 'word' variable elsewhere.

All general purpose variables are reset to 0 upon a program reset.

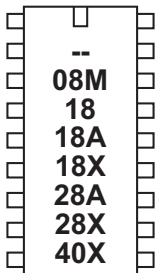

Storage Variables.

Storage variables are additional memory locations allocated for temporary storage of byte data. They cannot be used in mathematical calculations, but can be used to temporarily store byte values by use of the peek and poke commands.

The number of available storage locations varies depending on PICAXE type. The following table gives the number of available byte variables with their addresses. These addresses vary according to technical specifications of the microcontroller. See the poke and peek command descriptions for more information.

PICAXE-08	none	
PICAXE-08M	48	80 to 127 (\$50 to \$7F)
PICAXE-18	48	80 to 127 (\$50 to \$7F)
PICAXE-18A	48	80 to 127 (\$50 to \$7F)
PICAXE-18X	96	80 to 127 (\$50 to \$7F), 192 to 239 (\$C0 to \$EF)
PICAXE-28A	48	80 to 127 (\$50 to \$7F)
PICAXE-28X	112	80 to 127 (\$50 to \$7F), 192 to 239 (\$C0 to \$FF)
PICAXE-40X	112	80 to 127 (\$50 to \$7F), 192 to 239 (\$C0 to \$FF)

Special Function Variables

The special function variables available for use depend on the PICAXE type.

PICAXE-08 / 08M Special Function Registers

pins = the input / output port

dirs = the data direction register (sets whether pins are inputs or outputs)

infra = another term for variable b13, used within the 08M infrain2 command

The variable pins is broken down into individual bit variables for reading from individual inputs with an if...then command. Only valid input pins are implemented.

pins = x : x : x : pin4 : pin3 : pin2 : pin1 : x

The variable dirs is also broken down into individual bits.

Only valid bi-directional pin configuration bits are implemented.

dirs = x : x : x : dir4 : x : dir2 : dir1 : x

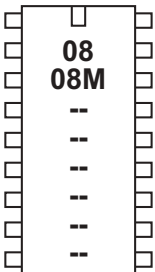

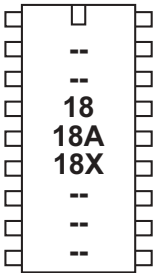

PICAXE-18 / 18A / 18X Special Function Registers

pins = the input port when reading from the port
 pins = the output port when writing to the port
 infra = a separate variable used within the infrain command
 keyvalue = another name for infra, used within the keyin command

Note that pins is a 'pseudo' variable that can apply to both the input and output port.

When used on the left of an assignment pins applies to the 'output' port e.g.

```
let pins = %11000011
```

will switch outputs 7,6,1,0 high and the others low.

When used on the right of an assignment pins applies to the input port e.g.

```
let b1 = pins
```

will load b1 with the current state of the input port.

Additionally, note that

```
let pins = pins
```

means 'let the output port equal the input port'

The variable pins is broken down into individual bit variables for reading from individual inputs with an if...then command. Only valid input pins are implemented.

```
pins = pin7 : pin6 : x : x : x : pin2 : pin1 : pin0
```

PICAXE-28A / 28X / 40X Special Function Registers

pins = the input port when reading from the port
 pins = the output port when writing to the port
 infra = a separate variable used within the infrain command
 keyvalue = another name for infra, used within the keyin command

Note that pins is a 'pseudo' variable that can apply to both the input and output port.

When used on the left of an assignment pins applies to the 'output' port e.g.

```
let pins = %11000011
```

will switch outputs 7,6,1,0 high and the others low.

When used on the right of an assignment pins applies to the input port e.g.

```
let b1 = pins
```

will load b1 with the current state of the input port.

Additionally, note that

```
let pins = pins
```

means 'let the output port equal the input port'

The variable pins is broken down into individual bit variables for reading from individual inputs with an if...then command.

```
pins = pin7 : pin6 : pin5 : pin4 : pin3 : pin2 : pin1 : pin0
```

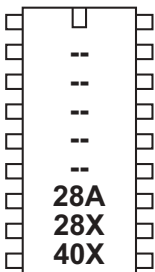

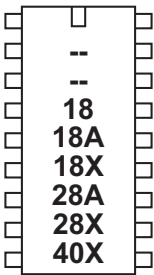

backward

Syntax:

BACKWARD motor

- Motor is the motor name A or B.

Function:

Make a motor output turn backwards

Information:

This is a 'pseudo' command designed for use by younger students with pre-assembled classroom models. It is actually equivalent to 'low 4 : high 5' (motor A) or 'low 6 : high 7' (motor B). This command is not normally used outside of the classroom.

Example:

```

loop: forward A      \ motor a on forwards
    wait 5           \ wait 5 seconds
    backward A      \ motor a on backwards
    wait 5           \ wait 5 seconds
    halt A          \ motor A stop
    wait 5           \ wait 5 seconds
    goto loop       \ loop back to start

```

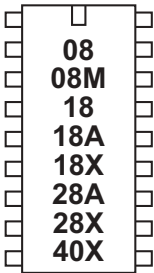

branch

Syntax:

BRANCH *offset*, (*address0*, *address1*...*addressN*)

- Offset is a variable/constant which specifies which Address# to use (0-N).

- Addresses are labels which specify where to go.

Function:

Branch to address specified by offset (if in range).

Information:

This command allows a jump to different program positions depending on the value of the variable 'offset'. If offset is value 0, the program flow will jump to address0, if offset is value 1 program flow will jump to address1 etc.

If offset is larger than the number of addresses the whole command is ignored and the program continues at the next line.

Example:

```

reset: let b1 = 0
       low 0
       low 1
       low 2
       low 3

main:  let b1 = b1 + 1
       if b1 > 3 then reset
       branch b1, (btn0, btn1, btn2, btn3)

btn0:  high 0
       goto main
btn1:  high 1
       goto main
btn2:  high 2
       goto main
btn3:  high 3
       goto main

```

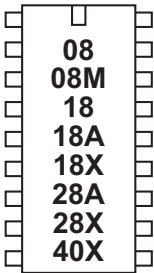

button

Syntax:

BUTTON pin,downstate,delay,rate,bytevariable,targetstate,address

- Pin is a variable/constant (0-7) which specifies the i/o pin to use.
- Downstate is a variable/constant (0 or 1) which specifies what logical state is read when the button is pressed.
- Delay is a variable/constant (0-255) which specifies time before a repeat if BUTTON is used within a loop.
- Rate is a variable/constant (0-255) which specifies the auto-repeat rate in BUTTON cycles.
- Bytevariable is the workspace. It must be cleared to 0 before being used by BUTTON for the first time.
- Targetstate is a variable/constant (0 or 1) which specifies what state (0=not pressed, 1=pressed) the button should be in for a branch to occur.
- Address is a label which specifies where to go if the button is in the target state.

Function:

Debounce button, auto-repeat, and branch if button is in target state.

Information:

When mechanical switches are activated the metal 'contacts' do not actually close in one smooth action, but 'bounce' against each other a number of times before settling. This can cause microcontrollers to register multiple 'hits' with a single physical action, as the microcontroller can register each bounce as a new hit. One simple way of overcoming this is to simply put a small pause (e.g. pause 10) within the program, this gives time for the switch to settle.

Alternately the button command can be used to overcome these issues. When the button command is executed, the microcontroller looks to see if the 'downstate' is matched. If this is true the switch is debounced, and then program flow jumps to 'address' if 'targetstate' = 1. If targetstate = '0' the program continues.

If the button command is within a loop, the next time the command is executed 'downstate' is once again checked. If the condition is still true, the variable 'bytevariable' is incremented. This can happen a number of times until 'bytevariable' value is equal to 'delay'. At this point a jump to 'address' is made if 'targetstate' = 1. Bytevariable is then reset to 0 and the whole process then repeats, but this time the jump to 'address' is made when the 'bytevariable' value is equal to 'rate'.

This gives action like a computer keyboard key press - send one press, wait for 'delay', then send multiple presses at time interval 'rate'.

Note that button should be used within a loop. It does not pause program flow and so only checks the input switch condition as program flow passes through the command.

Example:

```
loop:  button 0,0,200,100,b2,0,cont
                                     ` jump to cont unless pin0 = 0
      toggle 1                        ` else toggle input
      goto loop
cont:  etc.
```

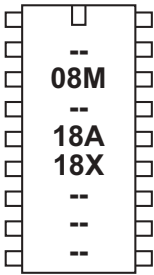

calibfreq

Syntax:

CALIBFREQ {-} factor

- factor is a constant/variable containing the value -31 to 31

Function:

Calibrate the microcontrollers internal resonator. 0 is the default factory setting.

Information:

Some PICAXE chips have an internal resonator that can be set to 4 or 8Mhz operation via the setfreq command.

On these chips it is also possible to 'calibrate' this frequency. This is an advanced feature not normally required by most users, as all chips are factory calibrated to the most accurate setting. Generally the only use for calibfreq is to slightly adjust the frequency for serial transactions with third party devices. A larger positive value increases speed, a larger negative value decreases speed. Try the values -4 to + 4 first, before going to a higher or lower value.

Use this command with extreme care. It can alter the frequency of the PICAXE chip beyond the serial download tolerance - in this case you will need to perform a 'hard-reset' in order to carry out a new download.

The calibfreq is actually a pseudo command that performs a 'poke' command on the microcontrollers OSCTUNE register (address \$90).

When the value is 0 to 31 the equivalent BASIC code is

```
poke $90, factor
pause 2
```

When the factor is -31 to -1 the equivalent BASIC code is

```
let b12 = 64 - factor
poke $90, factor
pause 2
```

Note that in this case variable b12 is used, and hence corrupted, by the command. This is necessary to poke the OSCTUNE register with the correct value.

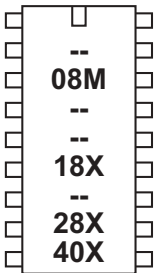

count

Syntax:

COUNT pin, period, variable

- Pin is a variable/constant (0-7) which specifies the input pin to use.
- Period is a variable/constant (1-65535ms at 4MHz).
- Variable receives the result (use a word variable) (0-65535).

Function:

Count pulses on an input pin.

Information:

Count checks the state of the input pin and counts the number of low to high transitions within the time 'period'. A word variable should be used for 'variable'. At 4MHz the input pin is checked every 20us, so the highest frequency of pulses that can be counted is 25kHz, presuming a 50% duty cycle (ie equal on-off time).

Take care with mechanical switches, which may cause multiple 'hits' for each switch push as the metal contacts 'bounce' upon closure.

Affect of increased clock speed:

The period value is 0.5ms at 8MHz and 0.25ms at 16MHz.

At 8MHz the input pin is checked every 10us, so the highest frequency of pulses that can be counted is 50kHz, presuming a 50% duty cycle (ie equal on-off time).

At 16MHz the input pin is checked every 5us, so the highest frequency of pulses that can be counted is 100kHz, presuming a 50% duty cycle (ie equal on-off time).

Example:

```
loop:
    count 1, 5000, w1      \ count pulses in 5 seconds
    debug w1              \ display value
    goto loop             \ else loop back to start
```

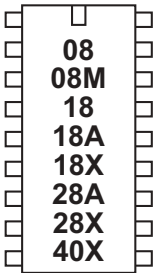

debug



Syntax:

DEBUG {var}

- Var is an optional variable value (e.g. b1). Its value is not of importance and is included purely for compatibility with older programs.

Function:

Display variable information in the debug window when the debug command is processed. Byte information is shown in decimal, binary, hex and ascii notation. Word information is shown in decimal and hex notation.

Information:

The debug command uploads the current variable values for **all** the variables via the download cable to the computer screen. This enables the computer screen to display all the variable values in the microcontroller for debugging purposes. Note that the debug command uploads a large amount of data and so significantly slows down any program loop.

To display user defined debugging messages use the 'sertxd' command instead.

Affect of increased clock speed:

When using an 8 or 16Mhz clock speed ensure the software has been set with the correct speed setting to enable successful communication between microcontroller and PC.

Example:

loop:

```

let b1 = b1 + 1  \ increment value of b1
readadc 2,b2    \ read an analogue value
debug b1        \ display values on computer screen
pause 500       \ wait 0.5 seconds
goto loop       \ loop back to start

```

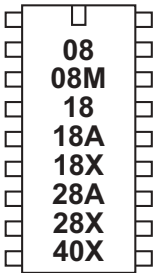

data

EEPROM

Syntax:

DATA {location},(data,data...)

EEPROM {location},(data,data...)

- Location is an optional constant (0-255) which specifies where to begin storing the data in the EEPROM. If no location is specified, storage continues from where it last left off. If no location was initially specified, storage begins at 0.
- Data are constants (0-255) which will be stored in the EEPROM.

Function:

Preload EEPROM data memory. If no EEPROM command is used the values are automatically cleared to the value 0. The keywords DATA and EEPROM have identical functions and either can be used.

Information:

This is not an instruction, but a method of pre-loading the microcontroller's data memory. The command does not affect program length.

With the PICAXE-08, 08M and 18 the data memory is shared with program memory. Therefore only unused bytes may be used within a program. To establish the length of the program use 'Check Syntax' from the PICAXE menu. This will report the length of program. Available data addresses can then be used as follows:

PICAXE-08	0 to (127 - number of used bytes)
PICAXE-08M	0 to (255 - number of used bytes)
PICAXE-18	0 to (127 - number of used bytes)

With the following microcontrollers the data memory is completely separate from the program and so no conflicts arise. The number of bytes available varies depending on microcontroller type as follows.

PICAXE-28, 28A	0 to 63
PICAXE-28X, 40X	0 to 127
PICAXE-18A, 18X	0 to 255

Example:

```
EEPROM 0,("Hello World")    ` save values in EEPROM

main:
  for b0 = 0 to 10          ` start a loop
    read b0,b1              ` read value from EEPROM
    serout 7,N2400,(b1)     ` transmit to serial LCD module
  next b0                   ` next character
```

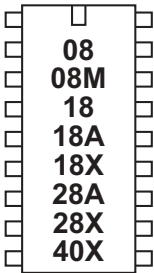
**end***Syntax:***END***Function:*

Sleep terminally until the power cycles (program re-runs) or the PC connects for a new download. Power is reduced to an absolute minimum (assuming no loads are being driven) and internal timers are switched off.

Information:

The end command places the microcontroller into low power mode after a program has finished. Note that as the compiler always places an END instruction after the last line of a program, this command is rarely required.

The end command switches off internal timers, and so commands such as servo and pwmout that require these timers will not function after an end command has been completed.

If you do not wish the end command to be carried out, place a 'stop' command at the bottom of the program. The stop command does not enter low power mode.

The main use of the end command is to separate the main program loop from sub-procedures as in the example below. This ensures that programs do not accidentally 'fall into' the sub-procedure.

*Example:***loop:**

```

let b2 = 15      \ set b2 value
pause 2000      \ wait for 2 seconds
gosub flsh      \ call sub-procedure
let b2 = 5      \ set b2 value
pause 2000      \ wait for 2 seconds
end             \ stop accidentally falling into sub

```

flsh:

```

for b0 = 1 to b2 \ define loop for b2 times
  high 1         \ switch on output 1
  pause 500      \ wait 0.5 seconds
  low 1          \ switch off output 1
  pause 500      \ wait 0.5 seconds
next b0         \ end of loop
return          \ return from sub-procedure

```

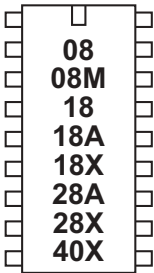

for...next

Syntax:

```
FOR variable = start TO end {STEP {-}increment}
```

```
(other program lines)
```

```
NEXT {variable}
```

- Variable will be used as the loop counter
- Start is the initial value of variable
- End is the finish value of variable
- Increment is an optional value which overrides the default counter value of +1. If Increment is preceded by a '-', it will be assumed that Start is greater than End, and therefore increment will be subtracted (rather than added) on each loop.

Function:

Repeat a section of code within a FOR-NEXT loop.

Information:

For...next loops are used to repeat a section of code a number of times. When a byte variable is used, the loop can be repeated up to 255 times. Every time the 'next' line is reached the value of variable is incremented (or decremented) by the step value (+1 by default). When the end value is exceeded the looping stops and program flow continues from the line after the next command.

For...next loops can be nested 8 deep (remember to use a different variable for each loop).

Example:

loop:

```
for b0 = 1 to 20  \ define loop for 20 times
  high 1          \ switch on output 1
  pause 500       \ wait 0.5 seconds
  low 1           \ switch off output 1
  pause 500       \ wait 0.5 seconds
next b0           \ end of loop

pause 2000       \ wait for 2 seconds
goto loop        \ loop back to start
```

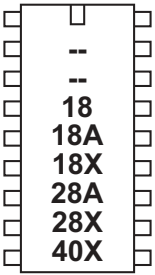

forward

Syntax:

FORWARD motor

- Motor is the motor name A or B.

Function:

Make a motor output turn forwards

Information:

This is a 'pseudo' command designed for use by younger students with pre-assembled classroom models. It is actually equivalent to 'high 4 : low 5' (motor A) or 'high 6: low 7' (motor B). This command is not normally used outside the classroom.

Example:

```

forward A      \ motor a on forwards
wait 5        \ wait 5 seconds
backward A    \ motor a on backwards
wait 5        \ wait 5 seconds
halt A        \ motor A reverse
wait 5        \ wait 5 seconds
goto loop     \ loop back to start

```

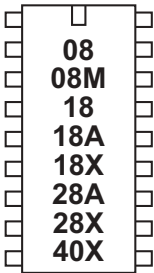

gosub



Syntax:

GOSUB address

- Address is a label which specifies where to gosub to.

Function:

Go to sub procedure at 'address', then 'return' at a later point.

Information:

The gosub ('goto subprocedure') command is a 'temporary' jump to a separate section of code, from which you will later return (via the return command). Every gosub command **MUST** be matched by a corresponding return command.

Do not confuse with the 'goto' command which is a permanent jump to a new program location.

The table shows the maximum number of gosubs available in each microcontroller. Gosubs can be nested 4 deep (ie there is a four level stack available in the microcontroller).

Note that for the option for 255 gosubs on the X parts you will require PICAXE-18X firmware >=8.2 or PICAXE-28X/40X firmware >=7.4

	Standard Gosub	Interrupt Gosub	Stack
PICAXE-08	16	0	4
PICAXE-08M	15	1	4
PICAXE-18	16	0	4
PICAXE-18A	15	1	4
PICAXE-18X	15 or 255	1	4
PICAXE-28A	15	1	4
PICAXE-28X	15 or 255	1	4
PICAXE-40X	15 or 255	1	4

Sub procedures are commonly used to reduce program space usage by putting repeated sections of code in a single sub-procedure. By passing values to the sub-procedure within variables, you can repeat a section of code from multiple places within the program. See the sample below for more information.

Example:

loop:

```

let b2 = 15      \ set b2 value
pause 2000      \ wait for 2 seconds
gosub flsh      \ call sub-procedure
let b2 = 5      \ set b2 value
pause 2000      \ wait for 2 seconds
gosub flsh      \ call sub-procedure
end             \ stop accidentally falling into sub

```

flsh:

```

for b0 = 1 to b2 \ define loop for b2 times
  high 1         \ switch on output 1
  pause 500      \ wait 0.5 seconds
  low 1          \ switch off output 1
  pause 500      \ wait 0.5 seconds
next b0          \ end of loop
return          \ return from sub-procedure

```

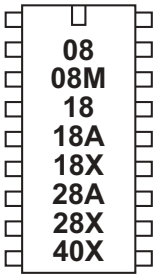

goto



Syntax:

GOTO address

- Address is a label which specifies where to go.

Function:

Go to address.

Information:

The goto command is a permanent 'jump' to a new section of the program. The jump is made to a label.

Example:

loop:

```
high 1           ` switch on output 1
pause 5000       ` wait 5 seconds
low 1            ` switch off output 1
pause 5000       ` wait 5 seconds
goto loop        ` loop back to start
```

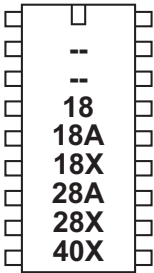

halt

Syntax:

HALT motor

- Motor is the motor name A or B.

Function:

Make a motor output stop.

Information:

This is a 'pseudo' command designed for use by younger students with pre-assembled classroom models. It is actually equivalent to 'low 4 : low 5' (motor A) or 'low 6: low 7' (motor B). This command is not normally used outside the classroom.

Example:

```

forward A      \ motor a on forwards
wait 5        \ wait 5 seconds
backward A    \ motor a on backwards
wait 5        \ wait 5 seconds
halt A        \ motor A reverse
wait 5        \ wait 5 seconds
goto loop     \ loop back to start

```

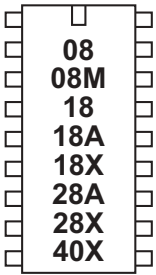

high



Syntax:

HIGH pin

- Pin is a variable/constant (0-7) which specifies the i/o pin to use.

Function:

Make pin output high.

Information:

The high command switches an output on (high).

On microcontrollers with configurable input/output pins (e.g. PICAXE-08) this command also automatically configures the pin as an output.

Example:

```
loop: high 1           ` switch on output 1
      pause 5000       ` wait 5 seconds
      low 1            ` switch off output 1
      pause 5000       ` wait 5 seconds
      goto loop        ` loop back to start
```

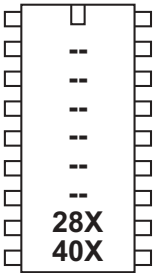

high portc

Syntax:

HIGH PORTC pin

- Pin is a variable/constant (0-7) which specifies the i/o pin to use.

Function:

Make pin on portc output high.

Information:

The high command switches a portc output on (high).

Example:

```
loop: high portc 1      \ switch on output 1
    pause 5000         \ wait 5 seconds
    low portc 1        \ switch off output 1
    pause 5000         \ wait 5 seconds
    goto loop          \ loop back to start
```

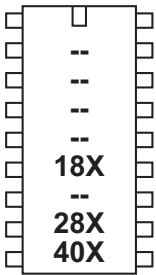
i2cslave

Syntax:

I2CSLAVE slave, speed, address

- Slave is the i2c slave address
- Speed is the keyword i2cfast (400kHz) or i2cslow (100kHz) at 4Mhz
- Address is the keyword i2cbyte or i2cword

Function:

The i2cslave command is used to configure the PICAXE pins for i2c use and to define the type of i2c device to be addressed.

Description:

Use of i2c parts is covered in more detail in the separate 'i2c Tutorial' datasheet.

If you are using a single i2c device you generally only need one i2cslave command within a program. With the PICAXE-18X device you should issue the command at the start of the program to configure the SDA and SCL pins as inputs to conserve power.

After the i2cslave has been issued, readi2c and writei2c can be used to access the i2c device.

Slave Address

The slave address varies for different i2c devices (see table below). For the popular 24LCxx series serial EEPROMs the address is commonly %1010xxxx.

Note that some devices, e.g. 24LC16B, incorporate the block address (ie the memory page) into bits 1-3 of the slave address. Other devices include the external device select pins into these bits. In this case care must be made to ensure the hardware is configured correctly for the slave address used.

Bit 0 of the slave address is always the read/write bit. However the value entered using the i2cslave command is ignored by the PICAXE, as it is overwritten as appropriate when the slave address is used within the readi2c and writei2c commands.

Speed

Speed of the i2c bus can be selected by using one of the two keywords i2cfast or i2cslow (400kHz or 100kHz). The internal slew rate control of the microcontroller is automatically enabled at the 400kHz speed (28/40X). Note that the 18X internal architecture means that the slower speed is always used with the 18X, as it is not capable of processing at the faster speed.

Affect of Increased Clock Speed:

Ensure you modify the speed keyword (i2cfast8, i2cslow8) at 8MHz or (i2cfast16, i2cslow16) at 16MHz for correct operation.

Address Size

i2c devices commonly have a single byte (i2cbyte) or double byte (i2cword) address. This must be correctly defined for the type of i2c device being used. If you use the wrong definition erratic behaviour will be experienced.

When using the i2cword address size you must also ensure the 'address' used in the readi2c and writei2c commands is a word variable.

Settings for some common parts:

Device	Type	Slave	Speed	Address
24LC01B	EE 128	%1010xxxx	i2cfast	i2cbyte
24LC02B	EE 256	%1010xxxx	i2cfast	i2cbyte
24LC04B	EE 512	%1010xxbx	i2cfast	i2cbyte
24LC08B	EE 1kb	%1010xbbx	i2cfast	i2cbyte
24LC16B	EE 2kb	%1010bbbx	i2cfast	i2cbyte
24LC64	EE 8kb	%1010dddx	i2cfast	i2cword
24LC256	EE 64kb	%1010dddx	i2cfast	i2cword
DS1307	RTC	%1101000x	i2cslow	i2cbyte
MAX6953	5x7 LED	%101dddx	i2cfast	i2cbyte
AD5245	Digital Pot	%010110dx	i2cfast	i2cbyte
SRF08	Sonar	%1110000x	i2cfast	i2cbyte
AXE033	I2C LCD	\$C6	i2cslow	i2cbyte
CMPS03	Compass	%1100000x	i2cfast	i2cbyte
SPE030	Speech	%1100010x	i2cfast	i2cbyte

x = don't care (ignored)
 b = block select (selects internal memory page within device)
 d = device select (selects device via external address pin polarity)

See readi2c or writei2c for example program for DS1307 real time clock.

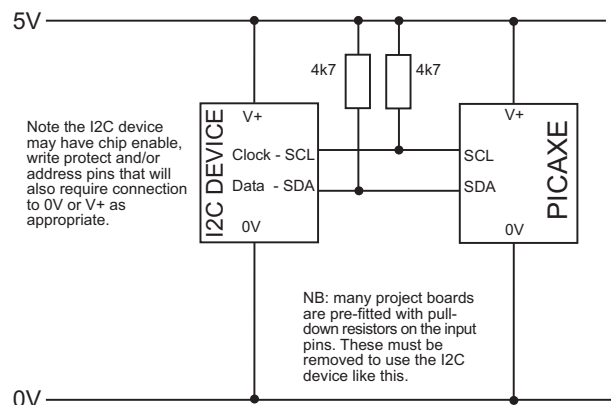

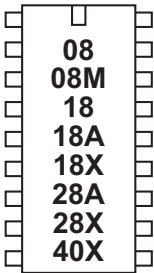

if...then

if...and...then

if...or...then



Syntax:

IF variable ?? value {AND/OR variable ?? value ...} **THEN** address

- Variable(s) will be compared to value(s).
- Value is a variable/constant.
- Address is a label which specifies where to go if condition is true.

?? can be any of the following conditions

- = equal to
- is equal to
- <> not equal to
- != not equal to
- > greater than
- >= greater than or equal to
- < less than
- <= less than or equal to

Function:

Compare and conditionally jump to a new program position.

Information:

The if...then command is used to test input pin variables (or general variables) for certain conditions. If these conditions are met program flow jumps to the new label. If the condition is not met the command is ignored and program flow continues on the next line.

When using inputs the input variable (pin1, pin2 etc) must be used (not the actual pin name 1, 2 etc.) i.e. the line must read 'if pin1 = 1 then...', not 'if 1 = 1 then...'

The if...then command only checks an input at the time the command is processed. Therefore it is normal to put the if...then command within a program loop that regularly scans the input. For details on how to permanently scan for an input condition using interrupts see the 'setint' command.

Examples:

Checking an input within a loop.

loop:

```
if pin0 = 1 then flsh ` jump to flsh if pin0 is high
goto loop           ` else loop back to start
```

```
flsh: high 1           ` switch on output 1
pause 5000            ` wait 5 seconds
low 1                 ` switch off output 1
goto loop             ` loop back to start
```

Multiple compares can be combined with the AND and OR keywords.

2 input AND gate

```
if pin1 = 1 and pin2 = 1 then label
```

3 input AND gate

```
if pin0 = 1 and pin1 = 1 and pin2 = 1 then label
```

2 input OR gate

```
if pin1 = 1 or pin2 = 1 then label
```

analogue value between certain values

```
readadc 1,b1
```

```
if b1 >= 100 and b1 <= 200 then label
```

To read the whole input port at once the variable 'pins' can be used

```
if pins = %10101010 then label
```

To read the whole input port and mask individual inputs (e.g. 6 and 7)

```
let b1 = pins & %11000000
```

```
if b1 = %11000000 then label
```

The words is (=), on (1) and off (0) can also be used with younger students.

loop:

```
if pin0 is on then flsh ` jump to flsh if pin0 is high
goto loop           ` else loop back to start
```

```
flsh: high 1           ` switch on output 1
pause 5000           ` wait 5 seconds
low 1                 ` switch off output 1
goto loop            ` loop back to start
```

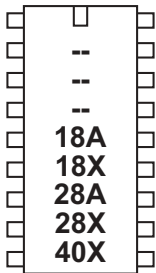

infrain

Syntax:

INFRAIN

Function:

Wait until a new infrared command is received.

Description:

This command is primarily used to wait for a new infrared signal from the infrared TV style transmitter. It can also be used with an infraout signal from a separate PICAXE-08M chip. All processing stops until the new command is received. The value of the command received is placed in the predefined variable 'infra'.

The infra-red input is input 0 on all parts that support this command.

The variable 'infra' is separate from the other byte variables.

After using this command you may have to perform a 'hard reset' to download a new program to the microcontroller. See the Serial Download section for more details.

Affect of Increased Clock Speed:

This command will only function at 4MHz

Use of TVR010 Infrared Remote Control:

The table shows the value that will be placed into the variable 'infra' depending on which key is pressed on the transmitter.

Before use (or after changing batteries) the TVR010 transmitter must be programmed with 'Sony' codes as follows:

1. Insert 3 AAA size batteries, preferably alkaline.
2. Press 'C'. The LED should light.
3. Press '2'. The LED should flash.
4. Press '1'. The LED should flash.
5. Press '2'. The LED should flash and then go out.

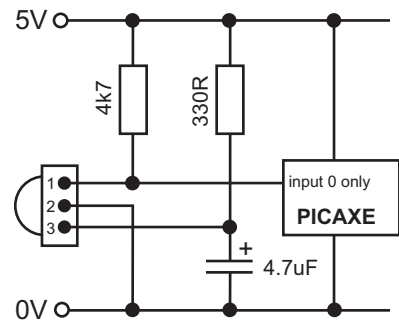
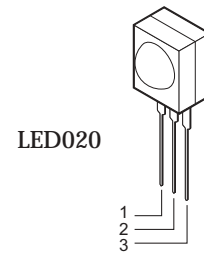
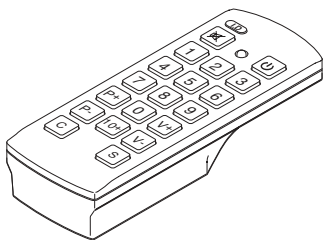

Key	Value
1	1
2	2
3	3
4	4
5	5
6	6
7	7
8	8
9	9
P+	10
0	11
V+	12
P-	13
10+	14
V-	15
Mute	16
Power	17

Example:

```

loop:
  infrain
  if infra = 1 then swon1
  if infra = 2 then swon2
  if infra = 3 then swon3
  if infra = 4 then swoff1
  if infra = 5 then swoff2
  if infra = 6 then swoff3
  goto loop

```

```

swon1:    high 1
          goto loop
swon2:    high 2
          goto loop
swon3:    high 3
          goto loop
swoff1:   low 1
          goto loop
swoff2:   low 2
          goto loop
swoff3:   low 3
          goto loop

```

```

'wait for new signal
'switch on 1
'switch on 2
'switch on 3
'switch off 1
'switch off 2
'switch off 3

```

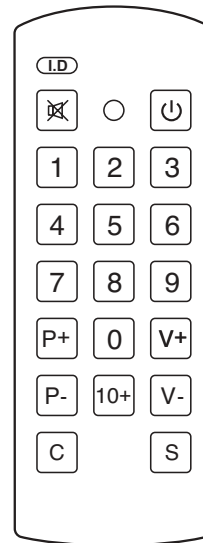

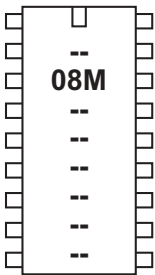

infrain2

Syntax:

INFRAIN2

Function:

Wait until a new infrared command is received.

Description:

This command is used to wait for an infraout signal from a separate PICAXE-08M chip. It can also be used with an infrared signal from the infrared TV style transmitter. All processing stops until the new command is received. The value of the command received is placed in the predefined variable 'infra'. This will be a number between 0 and 127. See the infraout command for more details about the values that will be received from the TVR010 remote control.

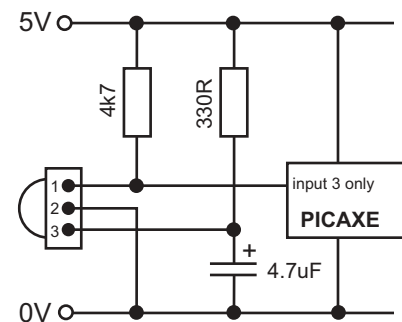
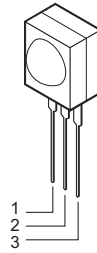

On the PICAXE-08M 'infra' is another name for 'b13' - it is the same variable. The infra-red input is fixed to input 3 on the PICAXE-08M.

After using this command you may have to perform a 'hard reset' to download a new program to the microcontroller. See the Serial Download section for more details.

Affect of Increased Clock Speed:

This command will only function at 4MHz. Use a setfreq m4 command before this command if using 8MHz speed,

Example:

```

loop:
  infrain2                'wait for new signal
  if infra = 1 then swon1  'switch on 1
  if infra = 2 then swon2  'switch on 2
  if infra = 4 then swoff1 'switch off 1
  if infra = 5 then swoff2 'switch off 2
  goto loop

swon1:    high 1
          goto loop
swon2:    high 2
          goto loop
swoff1:   low 1
          goto loop
swoff2:   low 2
          goto loop

```

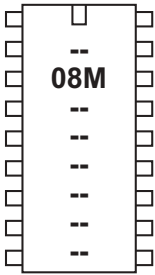

infraout

Syntax:

INFRAOUT device,data

- device is a constant/variable (valid device ID 1-31)
- data is a constant/variable (valid data 0-127)

Function:

Transmit an infra-red signal, modulated at 38kHz.

Description:

This command is used to transmit the infra-red data to Sony™ device (can also be used to transmit data to another PICAXE that is using the infrain or infrain2 command). Data is transmitted via an infra-red LED (connected on output 0) using the SIRC (Sony Infra Red Control) protocol.

device - 5 bit device ID (0-31)
 data - 7 bit data (0-127)

When using this command to transmit data to another PICAXE the device ID used must be value 1 (TV). The infraout command can be used to transmit any of the valid TV command 0-127. Note that the Sony protocol only uses 7 bits for data, and so data of value 128 to 255 is not valid.

Therefore the valid infraout command for use with infrain2 is

infraout 1,x ' (where x = 0 to 127)

Sony SIRC protocol:

The SIRC protocol uses a 38KHz modulated infra-red signal consisting of a start

Start	Data0	Data1	Data2	Data3	Data4	Data5	Data6	ID0	ID1	ID2	ID3	ID4
2.4ms	1.2 or 0.6ms	1.2 or 0.6ms	1.2 or 0.6ms	1.2 or 0.6ms	1.2 or 0.6ms	1.2 or 0.6ms	1.2 or 0.6ms	1.2 or 0.6ms	1.2 or 0.6ms	1.2 or 0.6ms	1.2 or 0.6ms	1.2 or 0.6ms

bit (2.4ms) followed by 12 data bits (7 data bits and 5 device ID bits). Logic level 1 is transmitted as a 1.2 ms pulse, logic 0 as a 0.6ms pulse. Each bit is separated by a 0.6ms silence period.

Example:

All commercial remote controls repeat the signal every 45ms whilst the button is held down. Therefore when using the PICAXE system higher reliability may be gained by repeating the transmission (e.g. 10 times) within a for..next loop.

```
for b1 = 1 to 10
  infraout 1,5
  pause 45
next b1
```

Interaction between infrain, infrain2 and infraout command.

Infrain and Infraout

The original infrain command was designed to react to signals from the TV style remote control TVR010. Therefore it only acknowledges the data sent from the 17 buttons on this remote (1-9, 0, 10+, P+, P-, V+, V-, MUTE, PWR) with a value between 1 and 17.

The infraout command can be used to 'emulate' the TVR010 remote to transit signals that will be acceptable for the infrain command. The values to be used for each TV remote button are shown in the table.

TVR010 TV Remote Control	infraout equivalent command	infrain variable data value	infrain2 variable data value
1	infraout 1,0	1	0
2	infraout 1,1	2	1
3	infraout 1,2	3	2
4	infraout 1,3	4	3
5	infraout 1,4	5	4
6	infraout 1,5	6	5
7	infraout 1,6	7	6
8	infraout 1,7	8	7
9	infraout 1,8	9	8
P+	infraout 1,16	10	16
0	infraout 1,9	11	9
V+	infraout 1,18	12	18
P-	infraout 1,17	13	17
10+	infraout 1,12	14	12
V-	infraout 1,19	15	19
MUTE	infraout 1,20	16	20
PWR	infraout 1,21	17	21

Infrain2 and Infraout

The infrain2 command will react to *any* of the valid TV data commands (0 to 127).

The infraout command can be used to transmit any of the valid TV command 0-127. Note that the Sony protocol only uses 7 bits for data, and so data of 128 to 255 is not valid.

Therefore the valid infraout command for use with infrain2 is (where x = 0 to 127)

infraout 1,x

Affect of Increased Clock Speed:

This command will only function at 4MHz.

Common Sony Device IDs.:

TV	1	VTR3	11
VTR1	2	Surround Sound	12
Text	3	Audio	16
Widescreen	4	CD Player	17
MDP / Laserdisk	6	Pro-Logic	18
VTR2	7	DVD	26

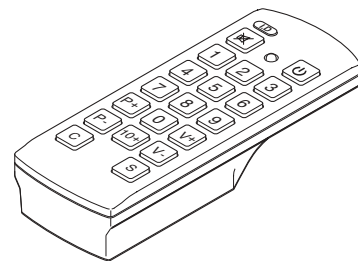

Button infraout data for a typical Sony TV (device ID 1)

000	1 button
001	2 button
002	3 button
003	4 button
004	5 button
005	6 button
006	7 button
007	8 button
008	9 button
009	10 button/0 button
011	Enter
016	channel up
017	channel down
018	volume up
019	volume down
020	Mute
021	Power
022	Reset TV
023	Audio Mode:Mono/SAP/Stereo
024	Picture up
025	Picture down
026	Color up
027	Color down
030	Brightness up
031	Brightness down
032	Hue up
033	Hue down
034	Sharpness up
035	Sharpness down
036	Select TV tuner
038	Balance Left
039	Balance Right
041	Surround on/off
042	Aux/Ant
047	Power off
048	Time display
054	Sleep Timer
058	Channel Display
059	Channel jump
064	Select Input Video 1
065	Select Input Video 2
066	Select Input Video 3

Button infraout data for a typical Sony TV (continued...)

- 074 Noise Reduction on/off
- 078 Cable/Broadcast
- 079 Notch Filter on/off
- 088 PIP channel up
- 089 PIP channel down
- 091 PIP on
- 092 Freeze screen
- 094 PIP position
- 095 PIP swap
- 096 Guide
- 097 Video setup
- 098 Audio setup
- 099 Exit setup
- 107 Auto Program
- 112 Treble up
- 113 Treble down
- 114 Bass up
- 115 Bass down
- 116 + key
- 117 - key
- 120 Add channel
- 121 Delete channel
- 125 Trinitone on/off
- 127 Displays a red RtestS on the screen

Button infraout data for a typical Sony VCR (device ID 2 or 7)

000	1 button
001	2 button
002	3 button
003	4 button
004	5 button
005	6 button
006	7 button
007	8 button
008	9 button
009	10 button/0 button
010	11 button
011	12 button
012	13 button
013	14 button
020	X 2 play w/sound
021	power
022	eject
023	L-CH/R-CH/Stereo
024	stop
025	pause
026	play
027	rewind
028	FF
029	record
032	pause engage
035	X 1/5 play
040	reverse visual scan
041	forward visual scan
042	TV/VTR
045	VTR from TV
047	power off
048	single frame reverse/slow reverse play
049	single frame advance/slow forward play
060	aux
070	counter reset
078	TV/VTR
083	index (scan)
106	edit play
107	mark

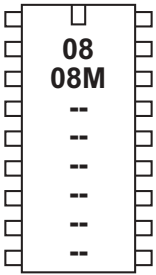

input

Syntax:

INPUT pin

- Pin is a variable/constant (0-7) which specifies the i/o pin to use.

Function:

Make pin an input.

Information:

This command is only required on microcontrollers with programmable input/output pins (e.g. PICAXE-08M). This command can be used to change a pin that has been configured as an output back to an input.

All pins are configured as inputs on first power-up (apart from out0 on the PICAXE-08, which is always an output).

Example:

loop:

```
input 1           \ make pin input
reverse 1         \ make pin output
reverse 1         \ make pin input
output 1          \ make pin output
```

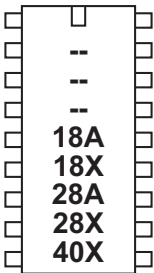

keyin

Syntax:

KEYIN

Function:

Wait until a new keyboard press is received.

Information:

This command is used to wait for a new key press from a computer keyboard (connected directly to the PICAXE - not the keyboard used whilst programming, see keyed command for connection details). All processing stops until the new key press is received. The value of the key press received is placed in the predefined variable 'keyvalue'.

Note the design of the keyboard means that the value of each key is not logical, each key value must be identified from the table on the next page. Some keys use two numbers, the first \$E0 is ignored by the PICAXE and so keyvalue will return the second number. Note all the codes are in hex and so should be prefixed with \$ whilst programming. The PAUSE and PRNT SCRN keys cannot be used reliably as they have a special long multi-digit code.. Also note that some keys may not work correctly when the 'Nums Lock' LED is set on with the keyed command.

The sample file 'keyin.bas' (installed in the \samples folder) provides details on how you can convert the key presses into ASCII characters by means of a look up table.

After using this command you may have to perform a 'hard reset' to download a new program to the microcontroller. See the Serial Download section for more details.

Affect of Increased Clock Speed:

This command will only function at 4MHz.

Example:

```

loop:
    keyin                                'wait for new signal
    if keyvalue = $45 then swon1         'switch on 1
    if keyvalue = $16 then swon2         'switch on 2
    if keyvalue = $25 then swoff1        'switch off 1
    if keyvalue = $2E then swoff2        'switch off 2
    goto loop

swon1:    high 1
          goto loop
swon2:    high 2
          goto loop
swoff1:   low 1
          goto loop
swoff2:   low 2
          goto loop

```

KEY	CODE	KEY	CODE	KEY	CODE
A	1C	9	46	[54
B	32	`	0E	INSERT	E0,70
C	21	-	4E	HOME	E0,6C
D	23	=	55	PG UP	E0,7D
E	24	\	5D	DELETE	E0,71
F	2B	BKSP	66	END	E0,69
G	34	SPACE	29	PG DN	E0,7A
H	33	TAB	0D	U ARROW	E0,75
I	43	CAPS	58	L ARROW	E0,6B
J	3B	L SHIFT	12	D ARROW	E0,72
K	42	L CTRL	14	R ARROW	E0,74
L	4B	L GUI	E0,1F	NUM	77
M	3A	L ALT	11	KP /	E0,4A
N	31	R SHFT	59	KP *	7C
O	44	R CTRL	E0,14	KP -	7B
P	4D	R GUI	E0,27	KP +	79
Q	15	R ALT	E0,11	KP EN	E0,5A
R	2D	APPS	E0,2F	KP .	71
S	1B	ENTER	5A	KP 0	70
T	2C	ESC	76	KP 1	69
U	3C	F1	05	KP 2	72
V	2A	F2	06	KP 3	7A
W	1D	F3	04	KP 4	6B
X	22	F4	06	KP 5	73
Y	35	F5	03	KP 6	74
Z	1A	F6	0B	KP 7	6C
0	45	F7	83	KP 8	75
1	16	F8	0A	KP 9	7D
2	1E	F9	01]	5B
3	26	F10	09	;	4C
4	25	F11	78	'	52
5	2E	F12	07	,	41
6	36	PRNT SCR	??	.	49
7	3D	SCROLL	7E	/	4A
8	3E	PAUSE	??		

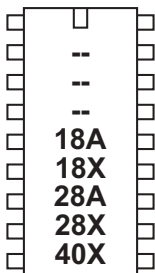

keyled

Syntax:

keyled mask

- Mask is a variable/constant which specifies the LEDs to use.

Function:

Set/clear the keyboard LEDs

Information:

This command is used to control the LEDs on a computer keyboard (connected directly to the PICAXE - not the keyboard used whilst programming). The mask value sets the operation of the LEDs.

Mask is used as follows:

Bit 0 - Scroll Lock (1=on, 0=off)

Bit 1 - Num Lock (1=on, 0=off)

Bit 2 - Caps Lock (1=on, 0=off)

Bit 3-6 - Not Used

Bit 7 - Disable Flash (1=no flash, 0=flash)

On reset mask is set to 0, and so all three LEDs will flash when the 'keyin' command detects a new key hit. This provides the user with feedback that the key press has been detected by the PICAXE. This flashing can be disabled by setting bit 7 of mask high. In this case the condition of the three LEDs can be manually controlled by setting/clearing bits 2-0.

Affect of Increased Clock Speed:

This command will only function at 4MHz.

Example:

loop:

```
keyled %10000111  \ all LEDs on
pause 500          \ pause 0.5s
keyled %10000000  \ all LEDs off
pause 500         \ pause 0.5s
goto loop         \ loop
```

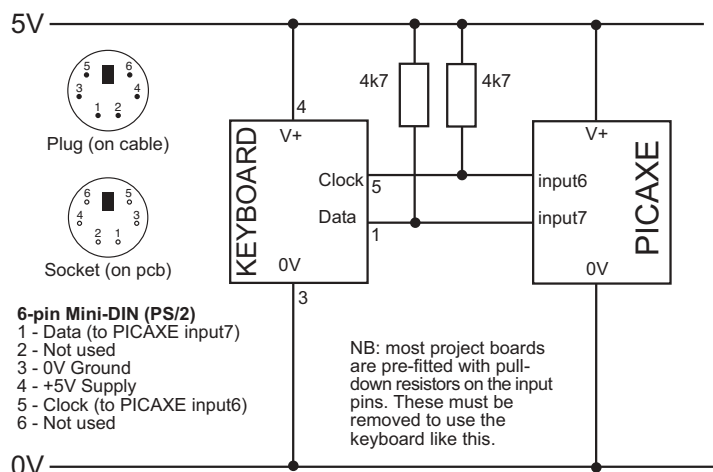

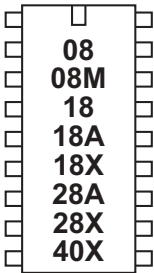
**let***Syntax:*

{LET} variable = {-} value ?? value ...

- Variable will be operated on.

- Value(s) are variables/constants which operate on variable.

Function:

Perform variable manipulation (wordsize-to-wordsize). Maths is performed strictly from left to right. The 'let' keyword is optional.

Information:

The microcontroller supports word (16 bit) mathematics. Valid integers are 0 to 65535. All mathematics can also be performed on byte (8 bit) variables (0-255). The microcontroller does not support fractions or negative numbers.

However it is sometimes possible to rewrite equations to use integers instead of fractions, e.g.

let w1 = w2 / 5.7

is not valid, but

let w1 = w2 * 10 / 57

is mathematically equal and valid.

The mathematical functions supported are:

+		; add	
-		; subtract	
*		; multiply	(returns low word of result)
**		; multiply	(returns high word of result)
/		; divide	(returns quotient)
//	(or %)	; modulus divide	(returns remainder)
MAX		; limit value to a maximum value	
MIN		; limit value to a minimum value	
&	(or AND)	; bitwise AND	
	(or OR)	; bitwise OR	(typed as SHIFT + \ on UK keyboard)
^	(or XOR)	; bitwise XOR	(typed as SHIFT + 6 on UK keyboard)
&/	(or ANDNOT)	; bitwise AND NOT	(NB this is <i>not</i> the same as NAND)
/	(or ORNOT)	; bitwise OR NOT	(NB this is <i>not</i> the same as NOR)
^/	(or XNOR)	; bitwise XOR NOT	(same as XNOR)

There is no shift left (<<) or shift right (>>) function. However the same function can be achieved by multiplying by 2 (shift left) or dividing by 2 (shift right).

All mathematics is performed strictly from left to right. It is not possible to enclose part equations in brackets e.g.

let w1 = w2 / (2 + b3)

is not valid. This would be entered as

let b3 = 2 + b3

let w1 = w2 / b3

The addition (+) and subtraction (-) commands work as expected. Note that the variables will overflow without warning if the maximum or minimum value is exceeded (0-255 for bytes variables, 0-65535 for word variables).

When multiplying two 16 bit word numbers the result is a 32 bit (double word) number. The multiplication (*) command returns the low word of a word*word calculation. The ** command returns the high word of the calculation.

The division (/) command returns the quotient (whole number) word of a word*word division. The modulus (// or %) command returns the remainder of the calculation.

The MAX command is a limiting factor, which ensures that a value never exceeds a preset value. In this example the value never exceeds 50. When the result of the multiplication exceeds 50 the max command limits the value to 50.

```
let b1 = b2 * 10 MAX 50
    if b2 = 3 then b1 = 30
    if b2 = 4 then b1 = 40
    if b2 = 5 then b1 = 50
    if b2 = 6 then b1 = 50      ' limited to 50
```

The MIN command is a similar limiting factor, which ensures that a value is never less than a preset value. In this example the value is never less than 50. When the result of the division is less than 50 the min command limits the value to 50.

```
let b1 = 100 / b2 MIN 50
    if b2 = 1 then b1 = 100
    if b2 = 2 then b1 = 50
    if b2 = 3 then b1 = 50      ' limited to 50
```

The AND, OR, XOR, XNOR commands function bitwise on each bit in the variables. ANDNOT and ORNOT mean, for example 'A AND the NOT of B' etc. This is not the same as NOT (A AND B), as with the traditional NAND command.

A common use of the AND (&) command is to mask individual bits:

```
let b1 = pins & %00000110
```

This masks inputs 1 and 2, so the variable only contains the data of these two inputs.

Example:

```
loop:
    let b0 = b0 + 1          ' increment b0
    sound 7,(b0,50)         ' make a sound
    if b0 > 50 then rest    ' after 50 reset
    goto loop               ' loop back to start

rest:
    let b0 = b0 max 10      ' limit b0 back to 10
                            ' as 10 is the maximum value
    goto loop               ' loop back to start
```

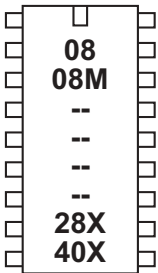

let dirs =

let dirsc =

Syntax:

{LET} dirs = value

{LET} dirsc = value

- Value(s) are variables/constants which operate on the data direction register.

Function:

Configure pins as inputs or outputs (let dirs =) (PICAXE-08/08M)

Configure pins as inputs or outputs on portc (let dirsc =) (PICAXE-28X/40X)

Information:

Some microcontrollers allow inputs to be configured as inputs or outputs. In these cases it is necessary to tell the microcontroller which pins to use as inputs and/or outputs (all are configured as inputs on first power up). There are a number of ways of doing this:

- 1) Use the input/output/reverse commands.
- 2) Use an output command (high, pulsout etc) that automatically configures the pin as an output.
- 3) Use the let dirs = statement.

When working with this statement it is conventional to use binary notation. With binary notation pin 7 is on the left and pin 0 is on the right. If the bit is set to 0 the pin will be an input, if the bit is set to 1 the pin will be an output.

Note that the 8 pin PICAXE have some pre-configured pins (e.g. pin 0 is always an output and pin 3 is always an input). Adjusting the bits for these pins will have no affect on the microcontroller.

Example:

```
let dirs = %00000011    ` switch pins 0 and 1 to outputs
let pins = %00000011    ` switch on outputs 0 and 1
```

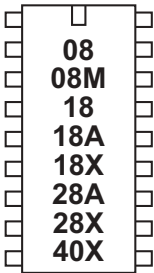

let pins =



let pinsc =

Syntax:

{LET} pins = value

{LET} pinsc = value

- Value(s) are variables/constants which operate on the output port.

Function:

Set/clear all outputs on the main output port (let pins =).

Set/clear all outputs on portc (let pinsc =) (PICAXE-28X/40X only)

Information:

High and low commands can be used to switch individual outputs high and low. However when working with multiple outputs it is often convenient to change all outputs simultaneously. When working with this statement it is conventional to use binary notation. With binary notation output7 is on the left and output0 is on the right. If the bit is set to 0 the output will be off (low), if the bit is set to 1 the output will be on (high).

Do not confuse the input port with the output port. These are separate ports on all except the 8 pin PICAXE. The command

`let pins = pins`

means 'make the output port the same as the input port'.

Note that on devices that have input/output bi-directional pins (08/08M), this command will only function on output pins. In this case it is necessary to configure the pins as outputs (using a let dirs = command) before use of this command.

Example:

```
let pins = %11000011    \ switch outputs 7,6,0,1 on
pause 1000              \ wait 1 second
let pins = %00000000    \ switch all outputs off
```

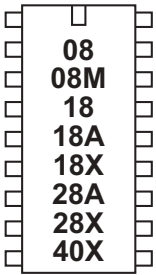

lookdown

Syntax:

LOOKDOWN target,(value0,value1...valueN),variable

- Target is a variable/constant which will be compared to Values.
- Values are variables/constants.
- Variable receives the result (if any).

Function:

Get target's match number (0-N) into variable (if match found).

Information:

The lookdown command should be used when you have a specific value to compare with a pre-known list of options. The target variable is compared to the values in the bracket. If it matches the 5th item (value4) the number '4' is returned in variable. Note the values are numbered from 0 upwards (not 1 upwards). If there is no match the value of variable is left unchanged.

In this example the variable b2 will contain the value 3 if b1 contains "d" and the value 4 if b1 contains "e"

Example:

```
lookdown b1, ("abcde"), b2
```

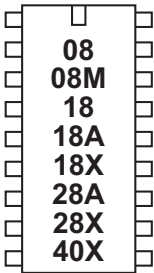

lookup

Syntax:

LOOKUP offset,(data0,data1...dataN),variable

- Offset is a variable/constant which specifies which data# (0-N) to place in Variable.
- Data are variables/constants.
- Variable receives the result (if any).

Function:

Lookup data specified by offset and store in variable (if in range).

Description:

The lookup command is used to load variable with different values. The value to be loaded in the position in the lookup table defined by offset. In this example if b0 = 0 then b1 will equal "a", if b0 =1 then b1 will equal "b" etc. If offset exceeds the number of entries in the lookup table the value of variable is unchanged.

Example:

loop:

```

let b0 = b0 + 1          \ increment b0
lookup b0,("abcd"),b1  \ put ascii character into b1
if b0 < 4 then loop     \ loop
end

```

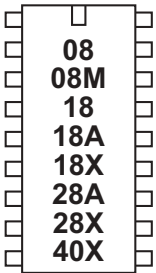

low



Syntax:

LOW pin

- Pin is a variable/constant (0-7) which specifies the i/o pin to use.

Function:

Make pin output low.

Information:

The low command switches an output off (low).

On microcontrollers with configurable input/output pins (e.g. PICAXE-08) this command also automatically configures the pin as an output.

Example:

```
loop: high 1           ` switch on output 1
      pause 5000       ` wait 5 seconds
      low 1            ` switch off output 1
      pause 5000       ` wait 5 seconds
      goto loop        ` loop back to start
```

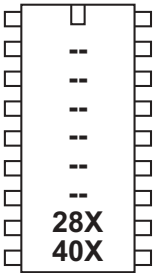

low portc

Syntax:

LOW PORTC pin

- Pin is a variable/constant (0-7) which specifies the i/o pin to use.

Function:

Make pin on portc output low.

Information:

The high command switches a portc output off (low).

Example:

```
loop: high portc 1      \ switch on output 1
    pause 5000         \ wait 5 seconds
    low portc 1        \ switch off output 1
    pause 5000         \ wait 5 seconds
    goto loop          \ loop back to start
```

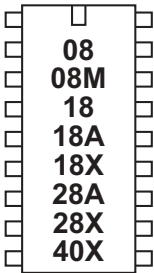
nap



Syntax:

NAP period

- Period is a variable/constant which determines the duration of the reduced-power nap (0-7).

Function:

Nap for a short period. Power consumption is reduced, but some timing accuracy is lost. A longer delay is possible with the sleep command.

Information:

The nap command puts the microcontroller into low power mode for a short period of time. When in low power mode all timers are switched off and so the pwmout and servo commands will cease to function. The nominal period of time is given by this table. Due to tolerances in the microcontrollers internal timers, this time is subject to -50 to +100% tolerance. The external temperature affects these tolerances and so no design that requires an accurate time base should use this command.

Period	Time Delay
0	18ms
1	32ms
2	72ms
3	144ms
4	288ms
5	576ms
6	1.152 s
7	2.304 s

Affect of increased clock speed:

The nap command uses the internal watchdog timer which is not affected by changes in resonator clock speed.

Example:

```

loop: high 1           \ switch on output 1
    nap 4              \ nap for 288ms
    low 1              \ switch off output 1
    nap 7              \ nap for 2.3 s
    goto loop         \ loop back to start

```

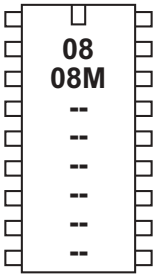

output

Syntax:

OUTPUT pin

- Pin is a variable/constant (0-7) which specifies the i/o pin to use.

Function:

Make pin an output.

Information:

This command is only required on microcontrollers with programmable input/output pins (e.g. PICAXE-08M). This command can be used to change a pin that has been configured as an input to an output.

All pins are configured as inputs on first power-up (apart from out0 on the PICAXE-08, which is always an output).

Example:

loop:

```
input 1      \ make pin input
reverse 1    \ make pin output
reverse 1    \ make pin input
output 1     \ make pin output
```

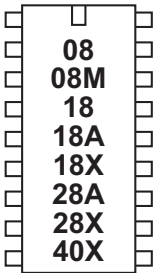

pause



Syntax:

PAUSE milliseconds

- Milliseconds is a variable/constant (0-65535) which specifies how many milliseconds to pause. (at 4MHz)

Function:

Pause for some time. The duration of the pause is as accurate as the resonator time-base, and presumes a 4MHz resonator.

Information:

The pause command creates a time delay (in milliseconds at 4MHz). The longest time delay possible is just over 65 seconds. To create a longer time delay (e.g. 5 minutes) use a for...next loop

```
for b1 = 1 to 5    ` 5 loops
  pause 60000      ` wait 60 seconds
next b1
```

During a pause the only way to react to inputs is via an interrupt (see the setint command for more information). Do not put long pauses within loops that are scanning for changing input conditions.

When using time delays longer than 5 seconds it may be necessary to perform a 'hard reset' to download a new program to the microcontroller. See the Serial Download section for more details.

Affect of increased clock speed:

The timebase is reduced to 0.5ms at 8MHz and 0.25ms at 16MHz.

Example:

```
loop: high 1        ` switch on output 1
  pause 5000        ` wait 5 seconds
  low 1             ` switch off output 1
  pause 5000        ` wait 5 seconds
  goto loop         ` loop back to start
```

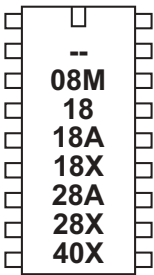

peek



Syntax:

PEEK location,variable

- Location is a variable/constant specifying a register address. Valid values are 0 to 255 (see below).
- Variable is a byte variable where the data is returned.

Function:

Read data from the microcontroller registers. This allows use of additional storage variables not defined by b0-b13.

Information:

The function of the poke/peek commands is two fold.

The most commonly used function is to store temporary byte data in the microcontrollers spare 'storage variable' memory. This allows the general purpose variables (b0 to b13) to be re-used in calculations. Remember that to save a word variable two separate poke/peek commands will be required - one for each of the two bytes that form the word.

Addresses \$50 to \$7F are general purpose registers that can be used freely.

Addresses \$C0 to \$EF can also be used by PICAXE-18X.

Addresses \$C0 to \$FF can also be used by PICAXE-28X, 40X.

The second function of the peek command is for experienced users to study the internal microcontroller SFR (special function registers).

Addresses \$00 to \$1F and \$80 to \$9F are special function registers (e.g. PORTB) which determine how the microcontroller operates. Avoid using these addresses unless you know what you are doing! The command uses the microcontroller FSR register which can address register banks 0 and 1 only.

Addresses \$20 to \$4F and \$A0 to \$BF are general purpose registers reserved for use with the PICAXE bootstrap interpreter. Poking these registers will produce unexpected results and could cause the interpreter to crash.

Example:

```
peek 80,b1 ` put value of register 80 into variable b1
```

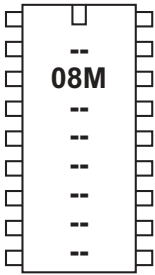

play



Syntax:

PLAY tune,LED

- Tune is a variable/constant (0 - 3) which specifies which tune to play
 - 0 - Happy Birthday
 - 1 - Jingle Bells
 - 2 - Silent Night
 - 3 - Rudolf the Red Nosed Reindeer
- LED is a variable/constant (0 -3) which specifies if other outputs flash at the same time as the tune is being played.
 - 0 - No outputs
 - 1 - Output 0 flashes on and off
 - 2 - Output 4 flashes on and off
 - 3 - Output 0 and 4 flash alternately

Function:

Play an internal tune on the PICAXE-08M (i/o pin2).

Description:

The PICAXE-08M can play musical tones. The PICAXE-08M is supplied with 4 pre-programmed internal tunes, which can be output via the play command. As these tunes are included within the PICAXE-08M bootstrap code, they use very little program memory. To generate your own tunes use the 'tune' command, although this requires a much greater amount of program memory.

See the Tune command for suitable piezo / speaker circuits.

Affect of increased clock speed:

The tempo (speed) of the tune is doubled at 8MHz!

Example:

```
play 3,1    ` rudolf red nosed reindeer with output 0 flashingpoke
```

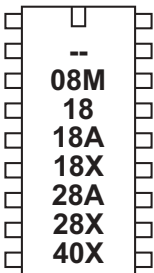

poke



Syntax:

POKE *location,data*

- Location is a variable/constant specifying a register address. Valid values are 0 to 255.
- Data is a variable/constant which provides the data byte to be written.

Function:

Write data into FSR location. This allows use of registers not defined by b0-b13.

Information:

The function of the poke/peek commands is two fold.

The most commonly used function is to store temporary byte data in the microcontrollers spare 'storage variable' memory. This allows the general purpose variables (b0 to b13) to be re-used in calculations. Remember that to save a word variable two separate poke/peek commands will be required - one for each of the two bytes that form the word.

Addresses \$50 to \$7F are general purpose registers that can be used freely.

Addresses \$C0 to \$EF can also be used by PICAXE-18X.

Addresses \$C0 to \$FF can also be used by PICAXE-28X, 40X.

The second function of the poke command is for experienced users to write values to the internal microcontroller SFR (special function registers).

Addresses \$00 to \$1F and \$80 to \$9F are special function registers (e.g. PORTB) which determine how the microcontroller operates. Avoid using these addresses unless you know what you are doing! The command uses the microcontroller FSR register which can address register banks 0 and 1 only.

Addresses \$20 to \$4F and \$A0 to \$BF are general purpose registers reserved for use with the PICAXE bootstrap interpreter. Poking these registers will produce unexpected results and could cause the interpreter to crash.

Example:

```
poke 80,b1      ` save value of b1 in register 80
```

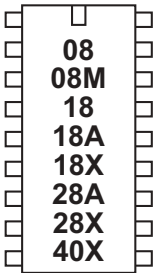

pulsin

Syntax:

PULSIN *pin,state,variable*

- Pin is a variable/constant (0-7) which specifies the i/o pin to use.
- State is a variable/constant (0 or 1) which specifies which edge must occur before beginning the measurement in 10us units (4MHz resonator).
- Variable receives the result (1-65535). If timeout occurs (0.65536s) the result will be 0.

Function:

Measure the length of an input pulse.

Information:

The pulsing command measures the length of a pulse. If no pulse occurs in the timeout period, the result will be 0. If state = 1 then a low to high transition starts the timing, if state = 0 a high to low transition starts the timing.

Use the count command to count the number of pulses with a specified time period.

It is normal to use a word variable with this command.

Affect of Increased Clock Speed:

4MHz	10us unit	0.65536s timeout
8MHz	5us unit	0.32768s timeout
16MHz	2.5us unit	0.16384s timeout

Example:

```
pulsin 3,1,w1    ` record the length of a pulse on pin 3 into b1
```

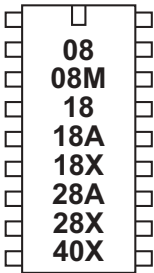

pulsout

Syntax:

PULSOUT *pin,time*

- Pin is a variable/constant (0-7) which specifies the i/o pin to use.
- Time is a variable/constant which specifies the period (0-65535) in 10us units (4MHz resonator).

Function:

Output a timed pulse by inverting a pin for some time.

Information:

The `pulsout` command generates a pulse of length `time`. If the output is initially low, the pulse will be high, and vice versa. This command automatically configures the pin as an output, but for reliable operation on 8 pin PICAXE you should ensure this pin is an output before using the command.

Affect of Increased Clock Speed:

4MHz	10us unit
8MHz	5us unit
16MHz	2.5us unit

Example:

```
loop:
    pulsout 4,150    ` send a 1.50ms pulse out of pin 4
    pause 20        ` pause 20 ms
    goto loop       ` loop back to start
```

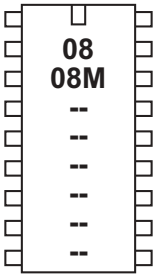
pwm

Syntax:

PWM *pin,duty,cycles*

- Pin is a variable/constant (0-7) which specifies the i/o pin to use.
- Duty is a variable/constant (0-255) which specifies analog level.
- Cycles is a variable/constant (0-255) which specifies number of cycles. Each cycle takes about 5ms.

Function:

Output pwm then return pin to input.

Information:

This command is rarely used. For pwm control of motors etc. the pwmout command is recommended instead.

This pwm command is used to provide 'bursts' of PWM output to generate a pseudo analogue output on the PICAXE-08. This is achieved with a resistor connected to a capacitor connected to ground; the resistor-capacitor junction being the analog output. PWM should be executed periodically to update/refresh the analog voltage.

Example:

```
loop:
    pwm 4,150,20    \ send 20 pwm bursts out of pin 4
    pause 20        \ pause 20 ms
    goto loop       \ loop back to start
```

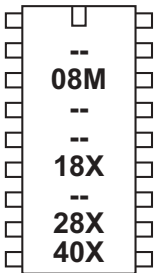

pwmout

Syntax:

PWMOUT pin,period,duty cycles

- Pin is a variable/constant which specifies the i/o pin to use.
(only 3 on 18X, only 2 on 08M, 1 or 2 is available on 28X/40X)
- Period is a variable/constant (0-255) which sets the PWM period
(period is the length of 1 on/off cycle i.e. the total mark:space time).
- Duty is a variable/constant (0-1023) which sets the PWM duty cycle.
(duty cycle is the mark or 'on time')

Function:

Generate a continuous pwm output using the microcontroller's internal pwm module

Information:

This command is **different** to most other BASIC commands in that the pwmout **runs continuously** (in the background) until another pwmout command is sent. Therefore it can be used, for instance, to continuously drive a motor at varying speeds. To stop pwmout send a command with period = 0.

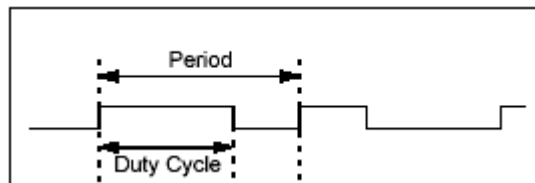

The PWM period = (period + 1) x 4 x resonator speed

(resonator speed for 4MHz = 1/4000000)

The PWM duty cycle = (duty) x resonator speed

Note that the period and duty values are linked by the above equations. If you wish to maintain a 50:50 mark-space ratio whilst increasing the period, you must also increase the duty cycle value appropriately. A change in resonator will change the formula.

NB: If you wish to know the frequency, PWM frequency = 1 / (the PWM period)

As the command uses the internal pwm module of the microcontroller there are certain restrictions to it's use:

- 1) The command only works on certain pins (28X/40X -1&2, 18X - 3, 08M -2).
- 2) Duty cycle is a 10 bit value (0 to 1023). The maximum duty cycle value must not be set greater than 4x the period, as the mark 'on time' would then be longer than the total PWM period (see equations above)! Setting above this value will cause erratic behaviour.
- 3) The pwm module uses a single timer for both pins on 28X/40X. Therefore when using PWMOUT on both pins the period will be the same for both pins.
- 4) The servo command cannot be used at the same time as the pwmout command as they both use the same timer.
- 5) pwmout stops during nap, sleep, or after an end command

Example:

loop:

```
pwmout 2,150,100 \ set pwm
pause 1000      \ pause 1 s
goto loop      \ loop back to start
```

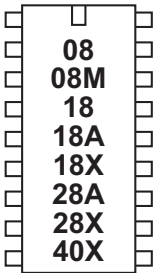

random



Syntax:

RANDOM wordvariable

- Variable is both the workspace and the result. As random generates a pseudo-random sequence it is advised to repeatedly call it within a loop. A word variable must be used.

Function:

Generate next pseudo-random number in a variable.

Description:

The random command generates a pseudo-random sequence of numbers between 0 and 65335. All microcontrollers must perform mathematics to generate random numbers, and so the sequence can never be truly random. On computers a changing quantity (such as the date/time) is used as the start of the calculation, so that each random command is different. The PICAXE does not contain such date functionality, and so the sequence it generates will always be identical unless the value of the word variable is set to a different value before the random command is used.

The most common way to overcome this issue is to repeatedly call the random command within a loop, e.g. whilst waiting for a switch push. As the number of loops will vary between switch pushes, the output is much more random.

If you only require a byte variable (0-255), still use the word variable (e.g. w0) in the command. As w0 is made up of b0 and b1, you can use either of these two bytes as your desired byte variable.

Example:

loop:

```
random w0          ` put random value into w0
if pin1 =1 then doit
goto loop
```

doit:

```
let pins = b1      ` put random byte value on output pins
pause 100          ` wait 0.1s
goto loop          ` loop back to start
```

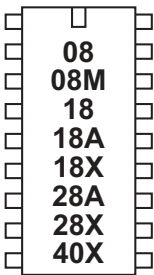

readadc



Syntax:

READADC channel,variable

- channel is a variable/constant specifying the input pin (0-7)

- Variable receives the data byte read.

Function:

Read the ADC channel (8 bit resolution) contents into variable.

Information:

The readadc command is used to read the analogue value from the microcontroller input pins. Note that not all inputs have internal ADC functionality - check the table below for the PICAXE chip you are using.

On microcontrollers with 'shared' inputs the ADC pin is also a digital input pin.

On microcontrollers with 'separate' inputs the ADC pins are separate pins.

The resolution of ADC is also shown in the table. The readadc command is used to read all types. However with 10 bit ADC types the reading will be rounded to a byte value 8 bits. Use the readadc10 command to read the full 10 bit value.

	Quantity	Type	Pin Numbers
PICAXE-08	1 - low	shared	1
PICAXE-08M	3 - 10 bit	shared	1,2,4
PICAXE-18	3 - low	shared	0,1,2
PICAXE-18A	3 - 8 bit	shared	0,1,2
PICAXE-18X	3 - 10 bit	shared	0,1,2
PICAXE-28A	4 - 8 bit	separate	0,1,2,3
PICAXE-28X	4 - 10 bit	separate	0,1,2,3
PICAXE-40X	7 - 10 bit	separate	0,1,2,3,5,6,7

Low-resolution ADC inputs are based upon the microcontrollers internal 16 step comparator rather than the conventional internal ADC module.

An 8-bit resolution analogue input will provide 256 different analogue readings (0 to 255) over the full voltage range (e.g. 0 to 5V). A low-resolution analogue input will provide 16 readings over the lower two-thirds of the voltage range (e.g. 0 to 3.3V). No readings are available in the upper third of the voltage range.

To ensure consistency between standard and low-resolution analogue input readings, the low-resolution reading on PICAXE-08 and 18 will 'jump' in 16 discrete steps between the nearest standard 8-bit readings, according to the table below.

Standard 8 Bit Reading	Low Resolution Reading
0-10	0
11-20	11
21-31	21
32-42	32
43-52	43
53-63	53
64-74	64
75-84	75
85-95	85
96-106	96
107-116	107
117-127	117
128-138	128
139-148	139
149-159	149
160-170	160
Values greater than 170 (170-255)	160

Example:

loop:

```
readadc 1,b1      \ read value into b1
if b1 > 50 then flsh \ jump to flsh if b1 > 50
goto loop        \ else loop back to start
```

flsh:

```
high 1           \ switch on output 1
pause 5000      \ wait 5 seconds
low 1            \ switch off output 1
goto loop       \ loop back to start
```

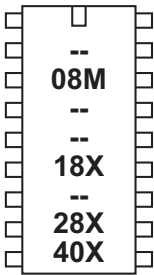

readadc10

Syntax:

READADC10 channel,wordvariable

- channel is a variable/constant specifying the input pin (0-7)

- wordvariable receives the data word read.

Function:

Read the ADC channel (10 bit resolution) contents into wordvariable.

Information:

The readadc10 command is used to read the analogue value from microcontrollers with 10-bit capability. Note that not all inputs have internal ADC functionality - check the table under 'readadc' command for the PICAXE chip you are using.

As the result is 10 bit a word variable must be used - for a byte value use the readadc command instead.

When using the debug command to output 10 bit numbers, the electrical connection to the computer via the download cable may slightly affect the ADC values. In this case it is recommended that the 'enhanced' interface circuit is used. The Schottky diode within this circuit reduces this affect.

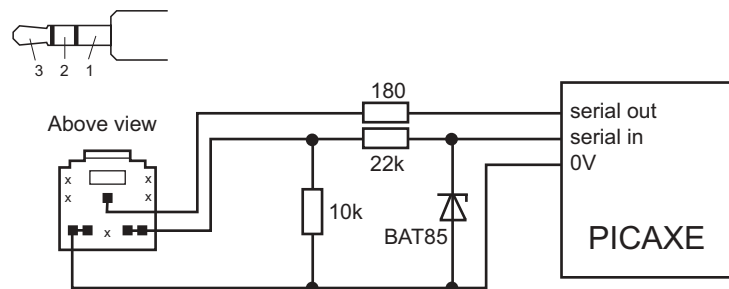

Example:

loop:

```

readadc 1,w1      \ read value into b1
debug w1         \ transmit to computer
pause 200        \ short delay
goto loop        \ loop back to start

```

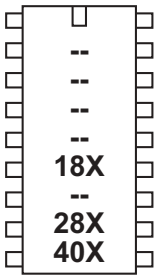

readi2c

Syntax:

READI2C location,(variable,...)

- Location is a variable/constant specifying a byte or word address.

- Variable(s) receives the data byte(s) read.

Function:

Read i2c location contents into variable(s).

Information:

Use of i2c parts is covered in more detail in the separate 'i2c Tutorial' datasheet.

This command is used to read byte data from an i2c device. Location defines the start address of the data read, although it is also possible to read more than one byte sequentially (if the i2c device supports sequential reads).

Location must be a byte or word as defined within the i2cslave command. An i2cslave command must have been issued before this command is used.

If the i2c hardware is incorrectly configured, or the wrong i2cslave data has been used, the value 255 (\$FF) will be loaded into each variable.

Example:

```
; Example of how to use DS1307 Time Clock
; Note the data is sent/received in BCD format.
```

```
' set DS1307 slave address
  i2cslave %11010000, i2cslow, i2cbyte
```

```
' read time and date and debug display
```

main:

```
  readi2c 0,(b0,b1,b2,b3,b4,b5,b6,b7)
  debug b1
  pause 2000
  goto main
```

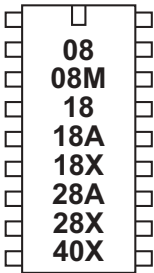

read



Syntax:

READ location,variable

- Location is a variable/constant specifying a byte-wise address (0-255).

- Variable receives the data byte read.

Function:

Read eeprom data memroy byte content into variable.

Information:

The read command allows byte data to be read from the microcontrollers data memory. The contents of this memory is not lost when the power is removed. However the data is updated (with the EEPROM command specified data) upon a new download. To save the data during a program use the write command.

The read command is byte wide, so to read a word variable two separate byte read commands will be required, one for each of the two bytes that makes the word (e.g. for w0, read both b0 and b1).

With the PICAXE-08, 08M and 18 the data memory is shared with program memory. Therefore only unused bytes may be used within a program. To establish the length of the program use 'Check Syntax' from the PICAXE menu. This will report the length of program. Available data addresses can then be used as follows:

PICAXE-08	0 to (127 - number of used bytes)
PICAXE-08M	0 to (255 - number of used bytes)
PICAXE-18	0 to (127 - number of used bytes)

With the following microcontrollers the data memory is completely separate from the program and so no conflicts arise. The number of bytes available varies depending on microcontroller type as follows.

PICAXE-28, 28A	0 to 63
PICAXE-28X, 40X	0 to 127
PICAXE-18A, 18X	0 to 255

Example:

loop:

```

for b0 = 0 to 63           \ start a loop
  read b0,b1              \ read value into b1
  serout 7,T2400,(b1)     \ transmit value to serial LCD
next b0                   \ next loop

```

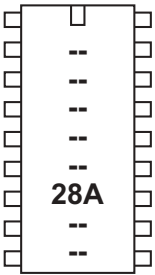
readmem

Syntax:

READMEM location,data

- Location is a variable/constant specifying a byte-wise address (0-255).

- Data is a variable into which the data is read.

Function:

Read FLASH program memory byte data into variable.

Information:

The data memory on the PICAXE-28A is limited to only 64 bytes. Therefore the readmem command provides an additional 256 bytes storage in a second data memory area. This second data area is not reset during a download.

This command is not available on the PICAXE-28X as a larger i2c external EEPROM can be used.

The readmem command is byte wide, so to read a word variable two separate byte read commands will be required, one for each of the two bytes that makes the word (e.g. for w0, read both b0 and b1).

Example:

```

loop: for b0 = 0 to 255           ` start a loop
      readmem b0,b1             ` read value into b1
      serout 7,T2400,(b1)       ` transmit value to serial LCD
next b0                          ` next loop

```

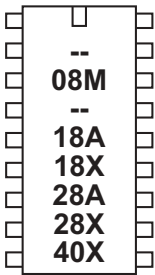

readtemp

Syntax:

READTEMP pin,variable

- Pin in the input pin.
- Variable receives the data byte read.

Function:

Read temperature from a DS18B20 digital temperature sensor and store in variable. The conversion takes up to 750ms.

Information:

The temperature is read back in whole degree steps, and the sensor operates from -55 to + 125 degrees celsius. Note that bit 7 is 0 for positive temperature values and 1 for negative values (ie negative values will appear as 128 + numeric value).

Note the readtemp command does not work with the older DS1820 or DS18S20 as they have a different internal resolution.

Affect of increased clock speed:

This command only functions at 4MHz.

Example:

loop:

```
readtemp 1,b1          \ read value into b1
if b1 > 127 then neg    \ test for negative
serout 7,N2400,(#b1)   \ transmit value to serial LCD
goto loop
```

neg:

```
let b1 = b1 - 128 \ adjust neg value
serout 7,N2400,("-") \ transmit negative symbol
serout 7,N2400,(#b1) \ transmit value to serial LCD
goto loop
```

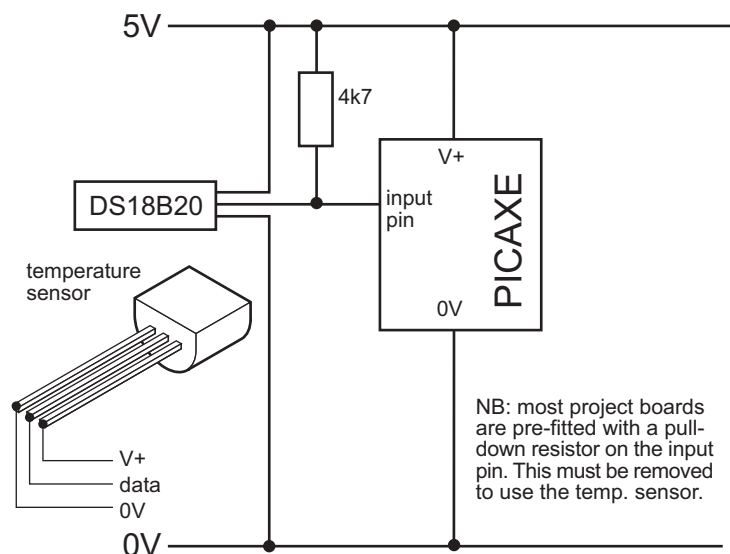

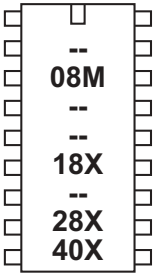

readtemp12

Syntax:

READTEMP12 pin,wordvariable

- Pin in the input pin.

- Variable receives the raw 12 bit data read.

Function:

Read 12 bit temperature data from a DS18B20 digital temperature sensor and store in variable. The conversion takes up to 750ms.

Information:

This command is for advanced users only. For standard 'whole degree' data use the readtemp command.

The temperature is read back as the raw 12 bit data into a word variable (0.125 degree resolution). The user must interpret the data through mathematical manipulation. See the DS18B20 datasheet (www.dalsemi.com) for more information on the 12 bit Temperature/Data relationship.

See the readtemp command for a suitable circuit.

Note the readtemp12 command does not work with the older DS1820 or DS18S20 as they have a different internal resolution.

Affect of increased clock speed:

This command only functions at 4MHz.

Example:

loop:

```
readtemp12 1,w1      ` read value into w1
debug w1             ` transmit to computer screen
goto loop
```

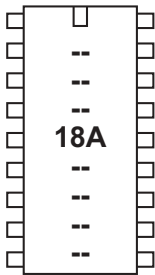

readowclk

Syntax:

`readowclk pin`

- Pin is a variable/constant (0-7) which specifies the i/o pin to use.

Function:

Read seconds from a DS2415 clock chip.

Information:

This command only applies to the PICAXE-18A. It is now rarely used as most users prefer to use the more powerful DS1307 i2c part interfaced to a PICAXE-18X microcontroller.

The DS2415 is an accurate 'second counter'. Every second, the 32 bit (4 byte) counter is incremented. Time is very accurate due to the use of a watch crystal. Therefore by counting elapsed seconds you can work out the accurate elapsed time. The 32 bit register is enough to hold 136 years worth of seconds. If desired the DS2415 can be powered by a separate 3V cell and so continue working when the main PICAXE power is removed.

Note that after first powering the DS2415 you must use a `resetowclk` command to activate the clock crystal and reset the counter. See the circuit diagram under the `resetowclk` command description.

The `readowclk` command reads the 32 bit counter and then puts the 32 bit value in variables b10 (LSB) to b13 (MSB) (also known as w6 and w7).

Using byte variables:

The number in b10 is the number of single seconds

The number in b11 is the number x 256 seconds

The number in b12 is the number x 65536 seconds

The number in b13 is the number x 16777216 seconds

Using word variables:

The number in w6 is the number of single seconds

The number in w7 is the number x 65536 seconds

Affect of Increased Clock Speed:

This command will only function at 4MHz.

Example:

```
main:
    resetowclk 2      ' reset the clock on pin2
loop:
    readowclk 2      ' read clock on input2
    debug b1         ' display the elapsed time
    pause 10000     ' wait 10 seconds
    goto loop
```

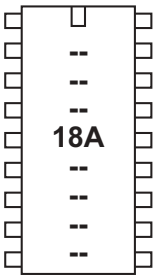

resetowclk

Syntax:

`resetowclk pin`

- Pin is a variable/constant (0-7) which specifies the i/o pin to use.

Function:

Reset seconds count to 0 on a DS2415 clock chip.

Information:

This command resets the time on a DS2415 one wire clock chip. It also switches the clock crystal on, and so must be used when the chip is first powered up to enable the time counting.

Affect of Increased Clock Speed:

This command will only function at 4MHz.

See the example under the readowclk command.

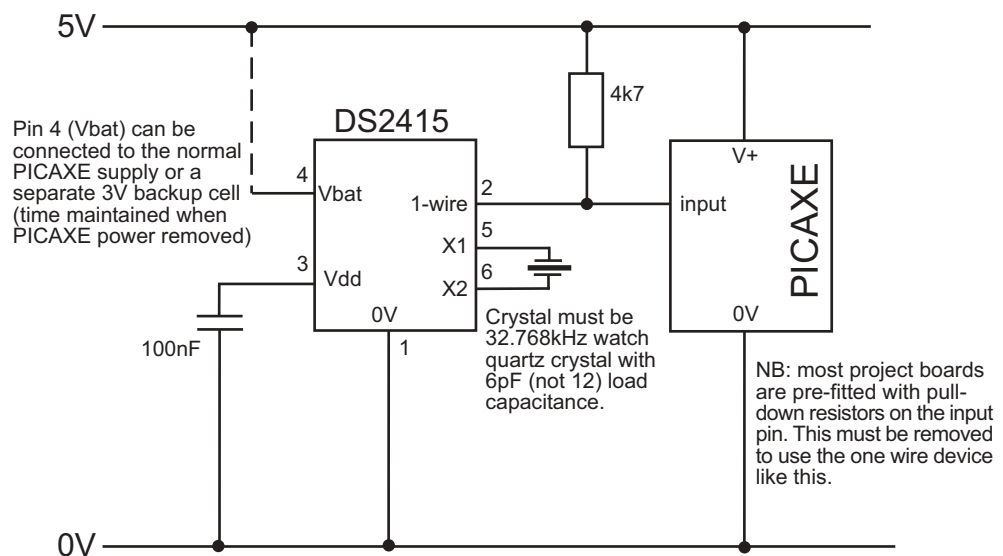

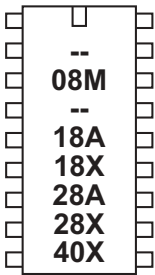

readownsn

Syntax:

readownsn pin

- Pin is a variable/constant (0-7) which specifies the i/o pin to use.

Function:

Read serial number from any Dallas 1-wire device.

Information:

This command (read-one-wire-serial-number) reads the unique serial number from any Dallas 1-wire device (e.g DS18B20 digital temp sensor, DS2415 clock, or DS1990A iButton).

If using an iButton device (e.g. DS1990A) this serial number is laser engraved on the casing of the iButton.

The readownsn command reads the serial number and then puts the family code in b6, the serial number in b7 to b12, and the checksum in b13

Note that you should not use variables b6 to b13 for other purposes in your program during a readownsn command.

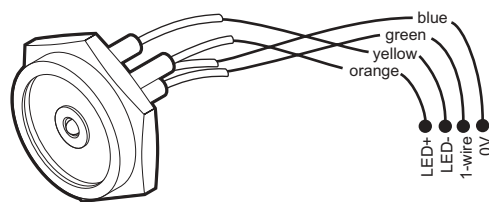
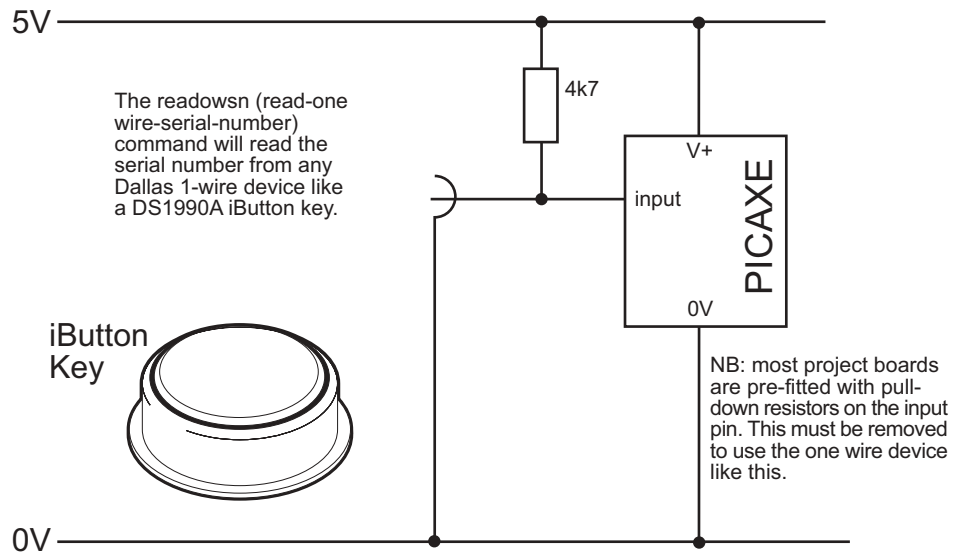

Part RSA002 - iButton Contact probe

Example:

```
main:
    let b6 = 0 ' reset family code to 0

    ' loop here reading numbers until the
    ' family code (b6) is no longer 0

loop:
    readown 2 ' read serial number on input2
    if b6 = 0 then loop

    ' Do a simple safety check here.
    ' b12 serial no value will not likely be FF
    ' if this value is FF, it means that the device
    ' was removed before a full read was completed
    ' or a short circuit occurred

    if b12 = $FF then main

    'Everything is ok so continue

    debug b1      ' ok so display
    pause 1000    ' short delay

    goto main
```

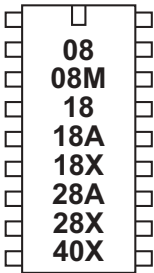

return



Syntax:

RETURN

Function:

Return from subroutine.

Information:

The return command is only used with a matching 'gosub' command, to return program flow back to the main program at the end of the sub procedure. If a return command is used without a matching 'gosub' beforehand, the program flow will crash.

Example:

loop:

```

let b2 = 15      \ set b2 value
pause 2000      \ wait for 2 seconds
gosub flsh      \ call sub-procedure
let b2 = 5      \ set b2 value
pause 2000      \ wait for 2 seconds
gosub flsh      \ call sub-procedure
end             \ stop accidentally falling into sub

```

flsh:

```

for b0 = 1 to b2 \ define loop for b2 times
  high 1         \ switch on output 1
  pause 500      \ wait 0.5 seconds
  low 1          \ switch off output 1
  pause 500      \ wait 0.5 seconds
next b0         \ end of loop
return         \ return from sub-procedure

```

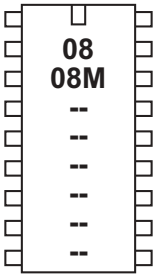
reverse

Syntax:

REVERSE pin

- Pin is a variable/constant (0-7) which specifies the i/o pin to use.

Function:

Make pin an output if now input and vice versa.

Information:

This command is only required on microcontrollers with programmable input/output pins (e.g. PICAXE-08M). This command can be used to change a pin that has been configured as an input to an output.

All pins are configured as inputs on first power-up (apart from out0 on the PICAXE-08, which is always an output). Note that pin3 is always an input.

Example:

loop:

```
input 1      \ make pin input
reverse 1    \ make pin output
reverse 1    \ make pin input
output 1     \ make pin output
```

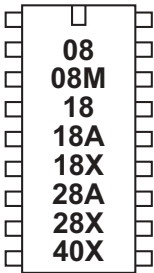

serin

Syntax:

SERIN pin,baudmode,(qualifier,qualifier...)

SERIN pin,baudmode,(qualifier,qualifier...),{#}variable,{#}variable...

SERIN pin,baudmode,{#}variable,{#}variable...

- Pin is a variable/constant (0-7) which specifies the i/o pin to use.
- Baudmode is a variable/constant (0-7) which specifies the mode:

T2400 true input (all baud rates at 4MHz)

T1200 true input

T600 true input

T300/T4800 true input

N2400 inverted input

N1200 inverted input

N600 inverted input

N300/N4800 inverted input

- Qualifiers are optional variables/constants (0-255) which must be received in exact order before subsequent bytes can be received and stored in variables.
- Variable(s) receive the result(s) (0-255). Optional #'s are for inputting ascii decimal numbers into variables, rather than raw characters.

Function:

Serial input with optional qualifiers (8 data, no parity, 1 stop).

Information:

The serin command is used to receive serial data into an input pin of the microcontroller. It cannot be used with the serial download input pin, which is reserved for program downloads only.

Pin specifies the input pin to be used. Baud mode specifies the baud rate and polarity of the signal. When using simple resistor interface, use N (inverted) signals. When using a MAX232 type interface use T (true) signals. The protocol is fixed at N,8,1 (no parity, 8 data bits, 1 stop bit).

Note that the 4800 baud rate is only available on the X parts. Note that the microcontroller may not be able to keep up with complicated datagrams at this speed - a maximum of 2400 is recommended when a 4 MHz resonator is used.

Qualifiers are used to specify a 'marker' byte or sequence. The command

```
serin 1,N2400,("ABC"),b1
```

requires to receive the string "ABC" before the next byte read is put into byte b1

Without qualifiers

```
serin 1,N2400,b1
```

the first byte received will be put into b1 regardless.

All processing stops until the new serial data byte is received. This command cannot be interrupted by the setint command. The following example simply waits until the sequence "go" is received.

```
serin 1,N2400,("go")
```

After using this command you may have to perform a 'hard reset' to download a new program to the microcontroller. See the Serial Download section for more details.

Affect of Increased Clock Speed:

Increasing the clock speed increases the serial baud rate as shown below. However due to the sensitive nature of serial communications it is recommended that only a 4MHz resonator is used.

Baudmode	4MHz	8MHz	16MHz
300	300	600	1200
600	600	1200	2400
1200	1200	2400	4800
2400	2400	4800	9600
4800	4800	9600	19200

A maximum of 4800 is recommended for complicated serial transactions.

Internal resonators are not as accurate as external resonators, so in high accuracy applications an external resonator device is recommended. However microcontrollers with an internal resonator may be used successfully in most applications, and may also be calibrated using the calibfreq command if required.

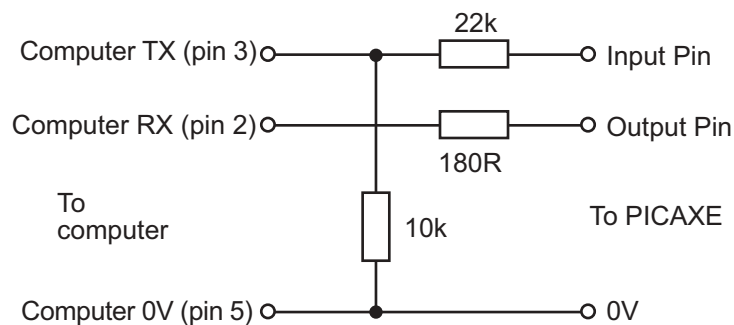

Example Computer Interface Circuit:

PICAXE-08/08M ONLY - Due to the internal structure of input3 (leg 4) of the PICAXE-08, a 1N4148 diode is required between the pin and V+ for serin to work on this particular pin ('bar' end of diode to V+) with this circuit. All other pins have an internal diode.

Example:

```
loop: for b0 = 0 to 63      \ start a loop
      serin 6,N2400,b1    \ receive serial value
      write b0,b1        \ write value into b1
next b0                    \ next loop
```

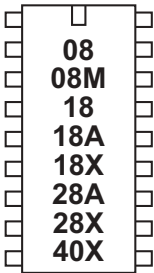

serout



Syntax:

SEROUT pin,baudmode,({#}data,{#}data...)

- Pin is a variable/constant (0-7) which specifies the i/o pin to use.

- Baudmode is a variable/constant (0-7) which specifies the mode:

T2400	true output	always driven
T1200	true output	always driven
T600	true output	always driven
T300/T4800	true output	always driven
N2400	inverted output	always driven
N1200	inverted output	always driven
N600	inverted output	always driven
N300/N4800	inverted output	always driven

(4800 is only available on X parts)

- Data are variables/constants (0-255) which provide the data to be output.

Optional #'s are for outputting ascii decimal numbers, rather than raw characters. Text can be enclosed in speech marks ("Hello")

Function:

Transmit serial data output (8 data bits, no parity, 1 stop bit).

Information:

The serout command is used to transmit serial data from an output pin of the microcontroller. It cannot be used with the serial download output pin - use the sertxd command in this case.

Pin specifies the output pin to be used. Baud mode specifies the baud rate and polarity of the signal. When using simple resistor interface, use N (inverted) signals. When using a MAX232 type interface use T (true) signals. The protocol is fixed at N,8,1 (no parity, 8 data bits, 1 stop bit).

Note that the 4800 baud rate is only available on the X parts. Note that the microcontroller may not be able to keep up with complicated datagrams at this speed - a maximum of 2400 is recommended when a 4 MHz resonator is used.

The # symbol allows ascii output. Therefore #b1, when b1 contains the data 126, will output the ascii characters "1" "2" "6" rather than the raw data 126.

Please also see the interfacing circuits, affect of resonator clock speed, and explanation notes of the 'serin' command, as all of these notes also apply to the serout command.

Example:

```
loop:
  for b0 = 0 to 63          \ start a loop
    read b0,b1             \ read value into b1
    serout 7,N2400,(b1)    \ transmit value to serial LCD
  next b0                  \ next loop
```

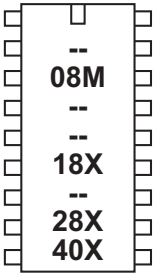

sertxd

Syntax:

SERTXD ({#}data,{#}data...)

- Data are variables/constants (0-255) which provide the data to be output.

Function:

Serial output via the serout programming pin (baud 4800, 8 data, no parity, 1 stop).

Information:

The sertxd command is similar to the serout command, but acts via the serial output pin rather than a general output pin. This allows data to be sent back to the computer via the programming cable. This can be useful whilst debugging data - view the uploaded data in the PICAXE>Terminal window. There is an option within View>Options>Options to automatically open the Terminal windows after a download.

The baud rate is fixed at 4800,n,8,1

Affect of Increased Clock Speed:

Increasing the clock speed increases the serial baud rate as shown below.

4MHz	8MHz	16MHz
4800	9600	19200

Example:

```
loop:
  for b1 = 0 to 63 ` start a loop
    sertxd("The value of b1 is ",#b1,13,10)
    pause 1000
  next b1          ` next loop
```

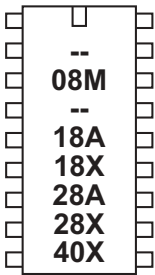

servo

Syntax:

SERVO pin,pulse

- Pin is a variable/constant (0-7) which specifies the i/o pin to use.
- Pulse is variable/constant (75-225) which specifies the servo position

Function:

Pulse an output pin continuously to drive a radio-control style servo

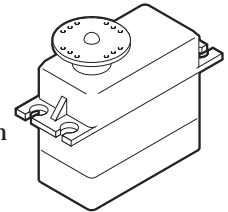

Information:

Servos, as commonly found in radio control toys, are a very accurate motor/gearbox assembly that can be repeatedly moved to the same position due to their internal position sensor. Generally servos require a pulse of 0.75 to 2.25ms every 20ms, and this pulse must be constantly repeated every 20ms. Once the pulse is lost the servo will lose its position.

The servo command starts a pin pulsing high for length of time pulse (x0.01 ms) every 20ms. This command is **different** to all other BASIC commands in that the pulsing mode **continues** until another servo, high or low command is executed. High and low commands stop the pulsing immediately. Servo commands adjust the pulse length to the new pulse value, hence moving the servo. Servo cannot be used at the same time as pwmout as they share a common timer.

Do not use a pulse value less than 75 or greater than 225, as this may cause the servo to malfunction. Due to tolerances in servo manufacture all values are approximate and will require fine-tuning by experimentation.

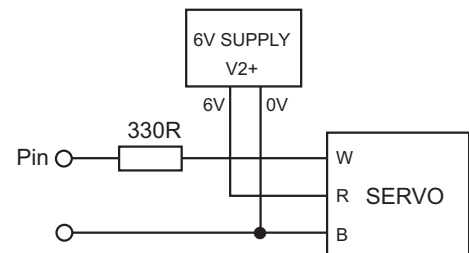

Always use a separate 6V (e.g 4x AA cells) power supply for the servo, as they generate a lot of electrical noise.

Note that the overhead processing time required for processing the servo commands every 20ms causes the other commands to be slightly extended i.e. a pause command will take slightly longer than expected. The servo pulses are also temporarily disabled during timing sensitive serin, serout, sertxd and debug commands.

Affect of increased clock speed:

The servo command will only function correctly at 4MHz.

Example:

```

loop: servo 4,75           \ move servo to one end
    pause 2000            \ wait 2 seconds
    servo 4,150           \ move servo to centre
    pause 2000            \ wait 2 seconds
    servo 4,225           \ move servo to other end
    pause 2000            \ wait 2 seconds
    goto loop             \ loop back to start

```

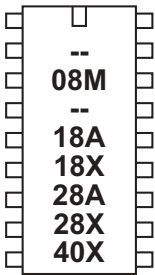

setint



Syntax:

SETINT input,mask

- input is a variable/constant (0-255) which specifies inputs condition.

- mask is variable/constant (0-255) which specifies the mask

Function:

Interrupt on a certain inputs condition.

Information:

The setint command causes a polled interrupt on a certain input pin condition.

A polled interrupt is a quicker way of reacting to a particular input combination. It is the only type of interrupt available in the PICAXE system. The inputs port is checked between execution of each command line in the program, between each note of a tune command, and continuously during any pause command. If the particular inputs condition is true, a 'gosub' to the interrupt sub-procedure is executed immediately. When the sub-procedure has been carried out, program execution continues from the main program.

The interrupt inputs condition is any pattern of '0's and '1's on the input port, masked by the byte 'mask'. Therefore any bits masked by a '0' in byte mask will be ignored.

e.g.

to interrupt on input1 high only

```
setint %00000010,%00000010
```

to interrupt on input1 low only

```
setint %00000000,%00000010
```

to interrupt on input0 high, input1 high and input 2 low

```
setint %00000011,%00000111
```

etc.

Only one input pattern is allowed at any time. To disable the interrupt execute a SETINT command with the value 0 as the mask byte.

Notes:

- 1) Every program which uses the SETINT command must have a corresponding interrupt: sub-procedure (terminated with a return command) at the bottom of the program.
- 2) When the interrupt occurs, the interrupt is permanently disabled. Therefore to re-enable the interrupt (if desired) a SETINT command must be used within the interrupt: sub-procedure itself. The interrupt will not be enabled until the 'return' command is executed.
- 3) If the interrupt is re-enabled and the interrupt condition is not cleared within the sub-procedure, a second interrupt may occur immediately upon the return command.
- 4) After the interrupt code has executed, program execution continues at the next program line in the main program. In the case of the interrupted pause, wait, play or tune command, any remaining time delay is ignored and the program continues with the next program line.

More detailed SETINT explanation.

The SETINT must be followed by two numbers - a 'compare with value' (input) and an 'input mask' (mask) in that order. It is normal to display these numbers in binary format, as it makes it more clear which pins are 'active'. In binary format input7 is on the left and input0 is on the right.

The second number, the 'input mask', defines which pins are to be checked to see if an interrupt is to be generated ...

- %00000001 will check input pin 0
- %00000010 will check input pin 1
- %01000000 will check input pin 6
- %10000000 will check input pin 7
- etc

These can also be combined to check a number of input pins at the same time...

- %00000011 will check input pins 1 and 0
- %10000100 will check input pins 7 and 2

Having decided which pins you want to use for the interrupt, the first number (inputs value) states whether you want the interrupt to occur when those particular inputs are on (1) or off (0).

Once a SETINT is active, the PICAXE monitors the pins you have specified in 'input mask' where a '1' is present, ignoring the other pins.

An input mask of %10000100 will check pins 7 and 2 and create a value of %a0000b00 where bit 'a' will be 1 if pin 7 is high and 0 if low, and bit 'b' will be 1 if pin 2 is high and 0 if low.

The 'compare with value', the first argument of the SETINT command, is what this created value is compared with, and if the two match, then the interrupt will occur, if they don't match then the interrupt won't occur.

If the 'input mask' is %10000100, pins 7 and 2, then the valid 'compare with value' can be one of the following ...

- %00000000 Pin 7 = 0 and pin 2 = 0
- %00000100 Pin 7 = 0 and pin 2 = 1
- %10000000 Pin 7 = 1 and pin 2 = 0
- %10000100 Pin 7 = 1 and pin 2 = 1

So, if you want to generate an interrupt whenever Pin 7 is high and Pin 2 is low, the 'input mask' is %10000100 and the 'compare with value' is %10000000, giving a SETINT command of ...

- SETINT %10000000,%10000100

The interrupt will then occur when, and only when, pin 7 is high and pin 2 is low. If pin 7 is low or pin 2 is high the interrupt will not happen as two pins are 'looked at' in the mask.

Example:

```

setint %10000000,%10000000
` activate interrupt when pin7 only goes high

loop:
  low 1                ` switch output 1 off
  pause 2000           ` wait 2 seconds
  goto loop            ` loop back to start

interrupt:
  high 1               ` switch output 1 on
  if pin7 = 1 then interrupt ` loop here until the
                        ` interrupt cleared
  pause 2000           ` wait 2 seconds
  setint %10000000,%10000000 ` re-activate interrupt
  return               ` return from sub

```

In this example an LED on output 1 will light immediately the input is switched high. With a standard if pin7=1 then.... type statement the program could take up to two seconds to light the LED as the if statement is not processed during the pause 2000 delay time in the main program loop (standard program shown below for comparison).

```

loop:
  low 1                ` switch output 1 off
  pause 2000           ` wait 2 seconds
  if pin7 = 1 then sw_on
  goto loop            ` loop back to start

sw_on:
  high 1               ` switch output 1 on
  if pin7 = 1 then sw_on
                        ` loop here until the condition is cleared
  pause 2000           ` wait 2 seconds
  goto loop            ` back to main loop

```

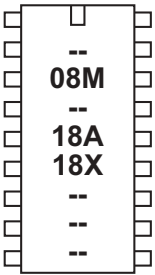

setfreq

Syntax:

```
setfreq freq
```

- freq is the keyword m4 or m8.

Function:

Set the internal clock frequency for microcontrollers with internal resonator to 4MHz (default) or 8MHz.

Information:

The setfreq command can be used to double the speed of operation of the microcontroller from 4MHz to 8MHz. However note that this speed increase affects many commands, by, for instance, changing their properties (e.g. all pause commands are half the length at 8MHz).

On devices with an external resonator this command cannot be used - the value of the external resonator must be changed to alter the clock frequency.

The change occurs immediately. All programs default to m4 (4MHz) if a setfreq command is not used. Note that you may have to perform a 'hard reset' at 4MHz if a new download fails after using this command.

The 8 and 4MHz frequencies are factory preset to the most accurate settings. However advanced users may use the calibfreq command to adjust these factory preset settings.

Some commands such as readtemp will only work at 4MHz. In these cases change back to 4MHz temporarily to operate these commands.

Example:

```
setfreq m4      \ setfreq to 4MHz
readtemp 1,b1   \ do command at 4MHz
setfreq m8      \ set freq back to 8MHz
```

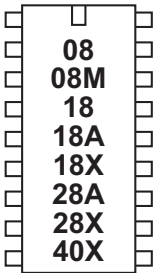

shiftin

Information:

The PICAXE microcontrollers do not have a shiftin command. However the same functionality found in other products can be achieved by using the sub procedures provided below. These sub-procedures are also saved in the file called shiftin_out.bas in the \samples folder of the Programming Editor software.

To use, simply copy the symbol definitions to the top of your program and copy the appropriate shiftin sub procedures to the bottom of your program.

Do not copy all options as this will waste memory space.

It is presumed that the data and clock outputs (sdata and sclk) are in the low condition before the gosub is used.

BASIC line

```
"shiftin serdata, sclk, mode, (var_in(\bits)) "
```

becomes

```
gosub shiftin_LSB_Pre      (for mode LSBPre)
gosub shiftin_MSB_Pre     (for mode MSBPre)
gosub shiftin_LSB_Post   (for mode LSBPost)
gosub shiftin_MSB_Post   (for mode MSBPost) '
```

```
\ ~~~~~ SYMBOL DEFINITIONS ~~~~~
\ Required for all routines. Change pin numbers/bits as required.
\ Uses variables b7-b13 (i.e. b7,w4,w5,w6). If only using 8 bits
\ all the word variables can be safely changed to byte variables.
\
\***** Sample symbol definitions *****
symbol sclk = 5           \ clock (output pin)
symbol sdata = 7         \ data (output pin for shiftout)
symbol serdata = input7  \ data (input pin for shiftin, note input7
symbol counter = b7      \ variable used during loop
symbol mask = w4         \ bit masking variable
symbol var_in = w5       \ data variable used durig shiftin
symbol var_out = w6      \ data variable used during shiftout
symbol bits = 8          \ number of bits
symbol MSBvalue = 128   \ MSBvalue
                          \ (=128 for 8 bits, 512 for 10 bits, 2048 for 12 bits)
```

```

=====
\ ~~~~~ SHIFTTIN ROUTINES ~~~~~
\ Only one of these 4 is required - see your IC requirements
\ It is recommended you delete the others to save space
=====
\ ***** Shiftin LSB first, Data Pre-Clock *****
shiftin_LSB_Pre:
    let var_in = 0
    for counter = 1 to bits \ number of bits
    var_in = var_in / 2 \ shift right as LSB first
    if serdata = 0 then skipLSBPre
    var_in = var_in + MSBValue \ set MSB if serdata = 1
skipLSBPre:
    pulsout sclk,1 \ pulse clock to get next data bit
    next counter
    return

=====
\ ***** Shiftin MSB first, Data Pre-Clock *****
shiftin_MSB_Pre:
    let var_in = 0
    for counter = 1 to bits \ number of bits
    var_in = var_in * 2 \ shift left as MSB first
    if serdata = 0 then skipMSBPre
    var_in = var_in + 1 \ set LSB if serdata = 1
skipMSBPre:
    pulsout sclk,1 \ pulse clock to get next data bit
    next counter
    return

=====
\ ***** Shiftin LSB first, Data Post-Clock ***** \
shiftin_LSB_Post: let var_in = 0
    for counter = 1 to bits \ number of bits
    var_in = var_in / 2 \ shift right as LSB first
    pulsout sclk,1 \ pulse clock to get next data bit
    if serdata = 0 then skipLSBPost
    var_in = var_in + MSBValue \ set MSB if serdata = 1
skipLSBPost:
    next counter
    return

=====
\ ***** Shiftin MSB first, Data Post-Clock *****
shiftin_MSB_Post: let var_in = 0
    for counter = 1 to bits \ number of bits
    var_in = var_in * 2 \ shift left as MSB first
    pulsout sclk,1 \ pulse clock to get next data bit
    if serdata = 0 then skipMSBPost
    var_in = var_in + 1 \ set LSB if serdata = 1
skipMSBPost:
    next counter
    return
=====

```

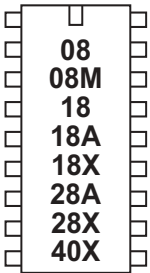

shiftout

Information:

The PICAXE microcontrollers do not have a shiftout command. However the same functionality found in other products can be achieved by using the sub procedures provided below. These sub-procedures are also saved in the file called `shiftn_out.bas` in the `\samples` folder of the Programming Editor software.

To use, simply copy the symbol definitions (listed within the `shiftn` command) to the top of your program and copy the appropriate shiftout sub procedures below to the bottom of your program.

Do not copy both options as this will waste memory space.

It is presumed that the data and clock outputs (`sdata` and `sclk`) are in the low condition before the `gosub` is used.

BASIC line

```
"shiftout sdata, sclk, mode, (var_out(\bits))"
```

becomes

```
gosub shiftout_LSBFirst    (for mode LSBFirst)
gosub shiftout_MSBFirst    (for mode MSBFirst)
```

Note the symbol definitions listed in the 'shiftn' command must also be used.

```
\=====
\ ***** Shiftout LSB first *****
shiftout_LSBFirst:
    for counter = 1 to bits          \ number of bits
    mask = var_out & 1                \ mask LSB
    low sdata                        \ data low
    if mask = 0 then skipLSB
    high sdata                        \ data high
skipLSB:    pulsout sclk,1            \ pulse clock for 10us
    var_out = var_out / 2            \ shift variable right for LSB
    next counter
    return

\=====
\ ***** Shiftout MSB first *****
shiftout_MSBFirst:
    for counter = 1 to bits          \ number of bits
    mask = var_out & MSBValue        \ mask MSB
    low sdata                        \ data low
    if mask = 0 then skipMSB
    high sdata                        \ data high
skipMSB:    pulsout sclk,1            \ pulse clock for 10us
    var_out = var_out * 2            \ shift variable left for MSB
    next counter
    return

\=====
```

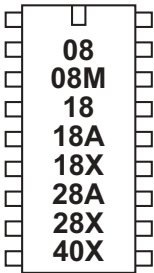

sleep



Syntax:

SLEEP period

- Period is a variable/constant which specifies the duration of sleep in multiples of 2.3 seconds (0-65535).

Function:

Sleep for some period (multiples of 2.3s).

Information:

The sleep command puts the microcontroller into low power mode for a period of time. When in low power mode all timers are switched off and so the pwmout and servo commands will cease to function. The nominal period is 2.3s, so sleep 10 will be approximately 23 seconds. The sleep command is not regulated and so due to tolerances in the microcontrollers internal timers, this time is subject to -50 to +100% tolerance. The external temperature affects these tolerances and so no design that requires an accurate time base should use this command.

Shorter 'sleeps' are possible with the 'nap' command.

Affect of increased clock speed:

The sleep command uses the internal watchdog timer which is not affected by changes in resonator clock speed.

Example:

```

loop: high 1           \ switch on output 1
    sleep 10          \ sleep for 23 seconds
    low 1             \ switch off output 1
    sleep 100         \ sleep for 230 seconds
    goto loop         \ loop back to start
  
```

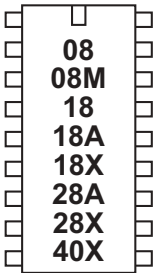

sound



Syntax:

SOUND pin,(note,duration,note,duration...)

- Pin is a variable/constant (0-7) which specifies the i/o pin to use.
- Note(s) are variables/constants (0-255) which specify type and frequency. Note 0 is silent for the duration. Notes 1-127 are ascending tones. Notes 128-255 are ascending white noises.
- Duration(s) are variables/constants (0-255) which specify duration (multiples of approx 10ms).

Function:

Play sound 'beep' noises.

Information:

This command is designed to make audible 'beeps' for games and keypads etc. To play music use the play or tune command instead. Note and duration must be used in 'pairs' within the command.

See the tune command for suitable piezo / speaker circuits.

Affect of Increased Clock Speed:

This length of the note is halved at 8MHz and quartered at 16MHz.

Example:

```
loop: let b0 = b0 + 1           \ increment b0
      sound 7,(b0,50)         \ make a sound
      goto loop                \ loop back to start
```

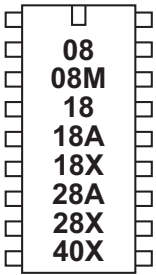

stop



Syntax:

STOP

Function:

Enter a permanent stop loop until the power cycles (program re-runs) or the PC connects for a new download.

Information:

The stop command places the microcontroller into a permanent loop at the end of a program. Unlike the end command the stop command does not put the the microcontroller into low power mode after a program has finished.

The stop command does not switch off internal timers, and so commands such as servo and pwmout that require these timers will continue to function.

Example:

loop:

```
pwmout 1,120,400
```

```
stop
```

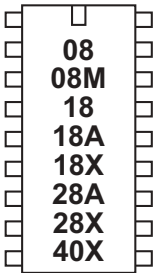
switch on/off

Syntax:

SWITCH ON pin

SWITCHON pin

SWITCH OFF pin

SWITCHOFF pin

- Pin is a variable/constant (0-7) which specifies the i/o pin to use.

Function:

Make pin output high / low.

Information:

This is a 'pseudo' command designed for use by younger students. It is actually equivalent to 'high' or 'low', ie the software outputs a high or low command as appropriate.

Example:

```

loop: switch on 7           \ switch on output 7
    wait 5                 \ wait 5 seconds
    switch off 7          \ switch off output 7
    wait 5                 \ wait 5 seconds
    goto loop             \ loop back to start

```

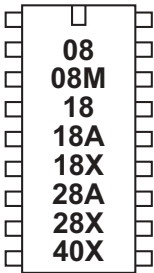

symbol

Syntax:

SYMBOL symbolname = value

SYMBOL symbolname = value ?? constant

- Symbolname is a text string which must begin with an alpha-character or '_'. After the first character, it can also contain number characters ('0'-'9').
- Value is a variable or constant which is being given an alternate symbolname.
- ?? can be any supported mathematical function e.g. + - * / etc.

Function:

Assign a value to a new symbol name.

Mathematical operators can also be used on constants (not variables)

Information:

Symbols are used to rename constants or variables to make them easier to remember during a program. Symbols have no effect on program length as they are converted back into 'numbers' before the download.

Symbols can contain numeric characters, but must not start with a numeric character. Naturally symbol names cannot be command names or reserved words such as input, step, etc. See the list of reserved words at the end of this section.

When using input and output pin definitions take care to use the term 'pin0' not '0' when describing input variables to be used within if...then statements.

Example:

```

symbol RED_LED = 7      \ define a output pin
symbol PUSH_SW = pin1  \ define a input switch
symbol COUNTER = B0    \ define a variable symbol

let COUNTER = 200 \ preload counter with 200
loop: high RED_LED   \ switch on output 7
pause COUNTER        \ wait 0.2 seconds
low RED_LED          \ switch off output 7
pause COUNTER        \ wait 0.2 seconds
goto LOOP            \ loop back to start

```

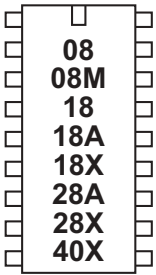

toggle



Syntax:

TOGGLE pin

- Pin is a variable/constant (0-7) which specifies the i/o pin to use.

Function:

Make pin output and toggle state.

Information:

The high command inverts an output (high if currently low and vice versa)

On microcontrollers with configurable input/output pins (e.g. PICAXE-08) this command also automatically configures the pin as an output.

Example:

loop:

```
toggle 7           \ toggle output 7
pause 1000         \ wait 1 second
goto loop          \ loop back to start
```

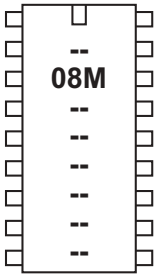

tune

Syntax:

TUNE LED, speed, (note, note, note...)

- LED is a variable/constant (0 -3) which specifies if other outputs flash at the same time as the tune is being played.
 - 0 - No outputs
 - 1 - Output 0 flashes on and off
 - 2 - Output 4 flashes on and off
 - 3 - Output 0 and 4 flash alternately
- speed is a variable/constant (1-15) which specifies the tempo of the tune.
- notes are the actual tune data generated by the Tune Wizard.

Function:

Plays a user defined musical tune on the PICAXE-08M.

Information:

The tune command allows musical 'tunes' to be played on the PICAXE-08M. Playing music on a microcontroller with limited memory will never have the quality of commercial playback devices, but the tune command performs remarkably well. Music can be played on economical piezo sounders (as found in musical birthday cards) or on better quality speakers.

The following information gives technical details of the note encoding process. However most users will use the 'Tune Wizard' to automatically generate the tune command, by either manually sequentially entering notes or by importing a mobile phone ring tone. Therefore the technical details are only provided for information only – they are not required to use the Tune Wizard.

Note that the tune command compresses the data, but the longer the tune the more memory that will be used. The 'play' command does not use up memory in the same way, but is limited to the 4 internal preset tunes.

All tunes play on a piezo sounder or speaker, connected to output 2 (leg 5) of the PICAXE-08M. Some sample circuits are shown later in this section.

Speed:

The speed of music is normally called 'tempo' and is the number of 'quarter beats per minute' (BPM). This is defined within the PICAXE system by allocating a value of 1-15 to the speed setting.

The sound duration of a quarter beat within the PICAXE is as follows:

$$\text{sound duration} = \text{speed} \times 65.64 \text{ ms}$$

Each quarter beat is also followed by a silence duration as follows,

$$\text{silence duration} = \text{speed} \times 8.20 \text{ ms}$$

Therefore the total duration of a quarter beat is:

$$\begin{aligned} \text{total duration} &= (\text{speed} \times 65.64) \\ &+ (\text{speed} \times 8.20) \\ &= \text{speed} \times 73.84 \text{ ms} \end{aligned}$$

Therefore the approximate number of beats per minute (bpm) are:

$$\text{bpm} = 60\,000 / (\text{speed} \times 73.84)$$

A table of different speed values are shown here. This gives a good range for most popular tunes.

Speed	BPM
1	812
2	406
3	270
4	203
5	162
6	135
7	116
8	101
9	90
10	81
11	73
12	67
13	62
14	58
15	54

Note that within electronic music a note normally plays for 7/8 of the total note time, with silence for 1/8. With the PICAXE the ratio is slightly different (8/9) due to memory and mathematical limitations of the microcontroller.

Note Bytes:

Each note byte is encoded into 8 bits as shown. The encoding is optimised to ensure the most common values (1/4 beat and octave 6) both have a value of 00. Note that as the PICAXE also performs further optimisation on the whole tune, the length of the tune will not be exactly the same length as the number of note bytes. 1/16, 1/32 and 'dotted' notes are not supported.

76 = Duration	54 = Octave	3210 = Note
00 = 1/4	00 = Middle Octave (6)	0000 = C
01 = 1/8	01 = High Octave (7)	0001 = C#
10 = 1	10 = Low Octave (5)	0010 = D
11 = 1/2	11 = not used	0011 = D#
		0100 = E
		0101 = F
		0110 = F#
		0111 = G
		1000 = G#
		1001 = A
		1010 = A#
		1011 = B
		11xx = Pause

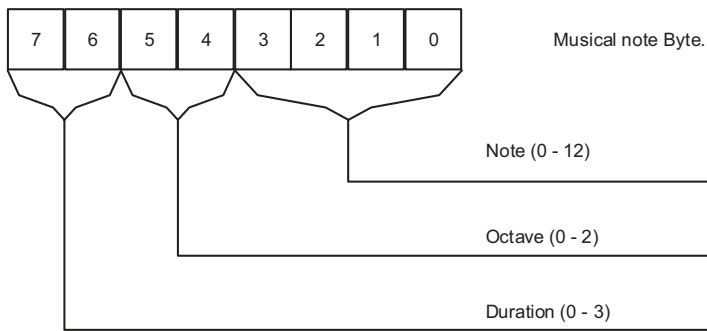

Piano Representation of Note Frequency

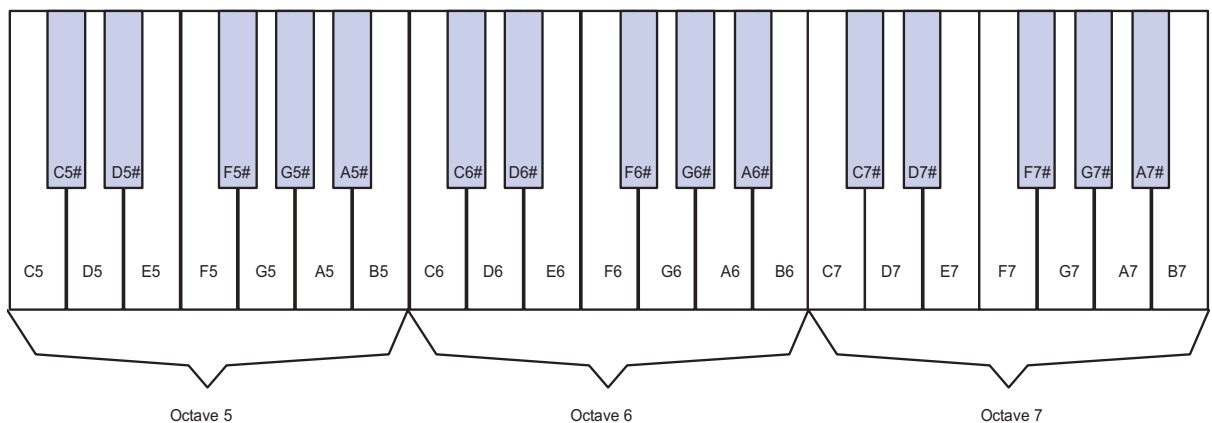

C5 = 262 Hz
 C5# = 277 Hz
 D5 = 294 Hz
 D5# = 311 Hz
 E5 = 330 Hz
 F5 = 349 Hz
 F5# = 370 Hz
 G5 = 392 Hz
 G5# = 415 Hz
 A5 = 440 Hz
 A5# = 466 Hz
 B5 = 494 Hz

C6 = 523 Hz ("Middle C")
 C6# = 554 Hz
 D6 = 587 Hz
 D6# = 622 Hz
 E6 = 659 Hz
 F6 = 698 Hz
 F6# = 740 Hz
 G6 = 784 Hz
 G6# = 831 Hz
 A6 = 880 Hz
 A6# = 932 Hz
 B6 = 988 Hz

C7 = 1047 Hz
 C7# = 1109 Hz
 D7 = 1175 Hz
 D7# = 1245 Hz
 E7 = 1318 Hz
 F7 = 1396 Hz
 F7# = 1480 Hz
 G7 = 1568 Hz
 G7# = 1661 Hz
 A7 = 1760 Hz
 A7# = 1865 Hz
 B7 = 1975 Hz

PICAXE-08M Tune Wizard

The Tune Wizard allows musical tunes to be created for the PICAXE-08M. Tunes can be entered manually using the drop-down boxes if desired, but most users will prefer to automatically import a mobile phone monophonic ringtone. These ringtones are widely available on the internet in RTTTL format (used on most Nokia phones). Note the PICAXE can only play one note at a time (monophonic), and so cannot use multiple note (polyphonic) ringtones.

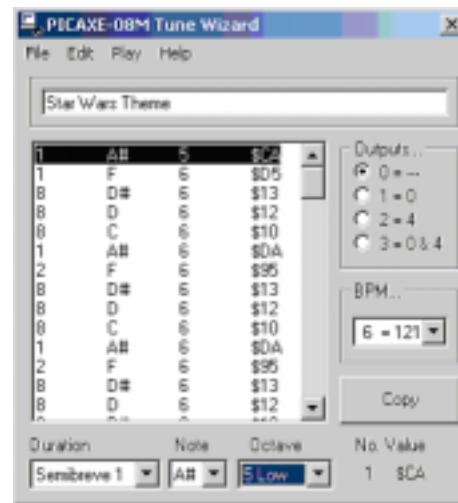

There are approximately 1000 tunes for free download on the software page of the www.picaxe.co.uk website. Some other possible sources for free ringtones are:

<http://www.ringtonerfest.com/>

<http://www.free-ringtones.eu.com/>

<http://www.tones4free.com/>

To start the Tune Wizard click the PICAXE>Wizard>Tune Wizard menu.

The easiest way to import a ringtone from the internet is to find the tune on a web page. Highlight the RTTTL version of the ringtone in the web browser and then click Edit>Copy. Move back to the Tune Wizard and then click Edit>Paste Ringtone.

To import a ringtone from a saved text file, click File>Import Ringtone.

Once the tune has been generated, select whether you want outputs 0 and 4 to flash as the tune plays (from the options within the 'Outputs' section).

The tune can then be tested on the computer by clicking the 'Play' menu (if your computer is fitted with soundcard and speakers). The tune played will give a rough idea of how the tune will sound on the PICAXE, but will differ slightly due to the different ways that the computer and PICAXE generate and playback sounds. On older computers the tune generation may take a couple of seconds as generating the tune is very memory intensive.

Once your tune is complete click the 'Copy' button to copy the tune command to the Windows clipboard. The tune can then be pasted into your main program.

Tune Wizard menu items:

File	New	Start a new tune
	Open	Open a previously saved tune
	Save As	Save the current tune
	Import Ringtone	Open a ringtone from a text file
	Export Ringtone	Save tune as a ringtone text file
	Export Wave	Save tune as a Windows .wav sound file
	Close	Close the Wizard
Edit	Insert Line	Insert a line in the tune
	Delete Line	Delete the current line
	Copy BASIC	Copy the tune command to Windows clipboard
	Copy Ringtone	Copy tune as a ringtone to Windows clipboard
	Paste BASIC	Paste tune command into Wizard
	Paste Ringtone	Paste ringtone into Wizard
Play		Play the current tune on the computer's speaker
Help	Help	Start this help file.

Ring Tone Tips & Tricks:

1. After generating the tune, try adjusting the tempo by increasing or decreasing the speed value by 1 and listening to which 'speed' sounds best.
2. If your ringtone does not import, make sure the song title at the start of the line is less than 50 characters long and that all the text is saved on a single line.
3. Ringtones that contain the instruction 'd=16' after the description, or that contain many notes starting with 16 or 32 (the odd one or two doesn't matter) will not play correctly at normal speed on the PICAXE. However they may sound better if you double the PICAXE processor speed by using a 'setfreq m8' command before the tune command.
4. The PICAXE import filters 'round-down' dotted notes (notes ending with '.'). You may wish to change these notes into longer notes after importing.

Sound Circuits for use with the play or tune command.

The simplest, most economical, way to play the tunes is to use a piezo sounder. These are simply connected between the output pin 2 (leg 5) of the PICAXE-08M and 0V (see circuits below).

The best piezo sound comes from the 'plastic cased' variants. Uncased piezos are also often used in schools due to their low cost, but the 'copper' side will need fixing to a suitable sound-board (piece of card, polystyrene cup or even the PCB itself) with double sided tape to amplify the sound.

For richer sounds a speaker should be used. Once again the quality of the sound-box the speaker is placed in is the most significant factor for quality of sound. Speakers can be driven directly (using a series capacitor) or via a simply push-pull transistor amplifier.

A 40 or 80 ohm speaker can be connected with two capacitors as shown. For an 8 ohm speaker use a combination of the speaker and a 33R resistor in series (to generate a total resistance of 39R).

The output can also be connected (via a simple RC filter) to an audio amplifier such as the TBA820M.

The sample .wav sound files in the \music sub-folder of the Programming Editor software are real-life recordings of tunes played (via a speaker) from the microcontroller chip.

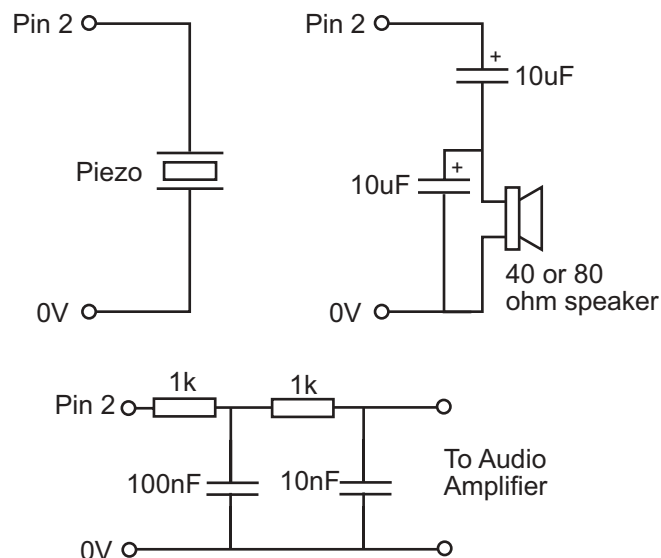

Ringing Tones Text Transfer Language (RTTTL) file format specification

```

<name> <sep> [<defaults>] <sep> <note-command>+
<name> := <char>+ ; max length 10 characters      PICAXE accepts up to 50
<sep> := ":"
<defaults> :=
<def-note-duration> |<def-note-scale> |<def-beats>
<def-note-duration> := "d=" <duration>
<def-note-octave> := "o=" <octave>
<def-beats> := "b=" <beats-per-minute>

; If not specified, defaults are
; duration = 4 (quarter note)
; octave = 6
; beats-per-minute = 63 (decimal value)          PICAXE defaults to 62

<note-command> :=
[<duration>] <note> [<octave>] [<special-duration>] <delimiter>

<duration> :=
"1" |           ; Full 1/1 note
"2" |           ; 1/2 note
"4" |           ; 1/4 note
"8" |           ; 1/8 note
"16" |          ; 1/16 note          Not used – PICAXE changes to 8
"32" |          ; 1/32 note         Not used – PICAXE changes to 8

<note> :=
"C" |
"C#" |
"D" |
"D#" |
"E" |
"F" |
"F#" |
"G" |
"G#" |
"A" |
"A#" |
"B" |           ; "H" can also be used      PICAXE exports using B
"P" |           ; pause

<octave> :=
"5" |           ; Note A is 440Hz
"6" |           ; Note A is 880Hz
"7" |           ; Note A is 1.76 kHz
"8" |           ; Note A is 3.52 kHz        Not used - PICAXE uses octave 7

<special-duration> :=
"." |           ; Dotted note              Not used - PICAXE rounds down

<delimiter> := " , "

```

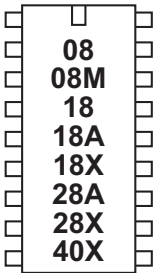

wait



Syntax:

`WAIT seconds`

- Seconds is a constant (1-65) which specifies how many seconds to pause.

Function:

Pause for some time in whole seconds.

Information:

This is a 'pseudo' command designed for use by younger students. It is actually equivalent to 'pause * 1000', i.e. the software outputs a pause command with a value 1000 greater than the wait value. Therefore this command cannot be used with variables. This command is not normally used outside the classroom.

Example:

`loop:`

```

switch on 7           \ switch on output 7
wait 5                \ wait 5 seconds
switch off 7          \ switch off output 7
wait 5                \ wait 5 seconds
goto loop             \ loop back to start

```

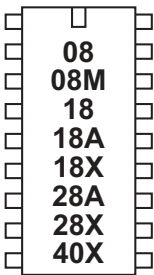

write



Syntax:

WRITE location,data

- Location is a variable/constant specifying a byte-wise address (0-255).

- Data is a variable/constant which provides the data byte to be written.

Function:

Write byte data content into data memory.

Information:

The write command allows byte data to be written into the microcontrollers data memory. The contents of this memory is not lost when the power is removed.

However the data is updated (with the EEPROM command specified data) upon a new download. To read the data during a program use the read command.

The write command is byte wide, so to write a word variable two separate byte write commands will be required, one for each of the two bytes that makes the word (e.g. for w0, write/read both b0 and b1).

With the PICAXE-08, 08M and 18 the data memory is shared with program memory. Therefore only unused bytes may be used within a program. To establish the length of the program use 'Check Syntax' from the PICAXE menu. This will report the length of program. Available data addresses can then be used as follows:

PICAXE-08	0 to (127 - number of used bytes)
PICAXE-08M	0 to (255 - number of used bytes)
PICAXE-18	0 to (127 - number of used bytes)

With the following microcontrollers the data memory is completely separate from the program and so no conflicts arise. The number of bytes available varies depending on microcontroller type as follows.

PICAXE-28, 28A	0 to 63
PICAXE-28X, 40X	0 to 127
PICAXE-18A, 18X	0 to 255

Example:

loop:

```

for b0 = 0 to 63      \ start a loop
  serin 6,T2400,b1   \ receive serial value
  write b0,b1        \ write value into b1
next b0              \ next loop

```

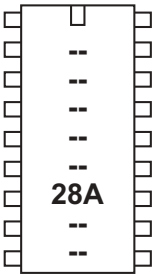

writemem

Syntax:

WRITEMEM location,data

- Location is a variable/constant specifying a byte-wise address (0-255).
- Data is a variable/constant which provides the data byte to be written.

Function:

Write FLASH program memory byte data into location.

Information:

The data memory on the PICAXE-28A is limited to only 64 bytes. Therefore the writemem command provides an additional 256 bytes storage in a second data memory area. This second data area is not reset during a download.

This command is not available on the PICAXE-28X as a larger i2c external EEPROM can be used.

The writemem command is byte wide, so to write a word variable two separate byte write commands will be required, one for each of the two bytes that makes the word (e.g. for w0, read both b0 and b1).

Example:

```
loop:
  for b0 = 0 to 255      \ start a loop
    serin 6,T2400,b1    \ receive serial value
    writemem b0,b1     \ write value into b1
  next b0               \ next loop
```

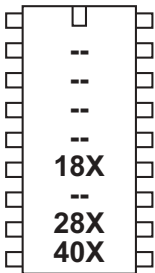

writei2c

Syntax:

WRITEI2C location,(variable,...)

- Location is a variable/constant specifying a byte or word address.

- Variable(s) contains the data byte(s) to be written.

Function:

Write i2c location contents from variable(s).

Information:

Use of i2c parts is covered in more detail in the separate 'i2c Tutorial' datasheet.

This command is used to write byte data to an i2c device. Location defines the start address of the data to be written, although it is also possible to read more than one byte sequentially (if the i2c device supports sequential reads).

Location must be a byte or word as defined within the i2cslave command. An i2cslave command must have been issued before this command is used.

Example:

```
; Example of how to use DS1307 Time Clock
; Note the data is sent/received in BCD format.
; Note that seconds, mins etc are variables that need
; defining e.g. symbol seconds = b0 etc.

' set DS1307 slave address
  i2cslave %11010000, i2cslow, i2cbyte

'write time and date e.g. to 11:59:00 on Thurs 25/12/03
start_clock:
  let seconds = $00 ' 00 Note all BCD format
  let mins    = $59 ' 59 Note all BCD format
  let hour    = $11 ' 11 Note all BCD format
  let day     = $03 ' 03 Note all BCD format
  let date    = $25 ' 25 Note all BCD format
  let month   = $12 ' 12 Note all BCD format
  let year    = $03 ' 03 Note all BCD format
  let control = %00010000 ' Enable output at 1Hz

  writei2c 0, (seconds,mins,hour,day,date,month,year,control)
end
```

Additional Reserved Keywords

In addition to the command names (see index on page 1-2), the following are also reserved keywords within the compiler. These words may not be used as labels or symbols within a program.

a, and, andnot
b, b0 -b13, bit0 - bit15
cls, cr
dirs, dir0 - dir7
i2cfast, i2cfast8, i2cfast16, i2cslow, i2cslow8, i2cslow16
inputa, infra, input0-input7, is
lf, keyvalue
m4, m8
n300, n600, n1200, n2400, n4800
on, off, or, ornot, output0 - output7, output0-output7
pin0 - pin7, port, pot
step
to, t300, t600, t1200, t2400, t4800
w0, w1, w2, w3, w4, w5, w6, w7
xnor, xor, xornot

Software Version

The latest version of the Programming Editor can be downloaded from the following website:

www.picaxe.co.uk

This manual was prepared using version 4.1.0 of the software. Ensure you are using this version or later when referencing this manual.

A very active forum for the discussion of PICAXE projects, and for technical support, also exists at this site.

Contact Address:

Revolution Education Ltd
4 Old Dairy Business Centre, Melcombe Road, Bath, BA2 3LR
<http://www.rev-ed.co.uk/>

Acknowledgements:

Revolution Education would like to thank the following:

Clive Seager
Vardan Antonyan
John Bown
LTScotland
Higher Still Development Unit
UKOOA